

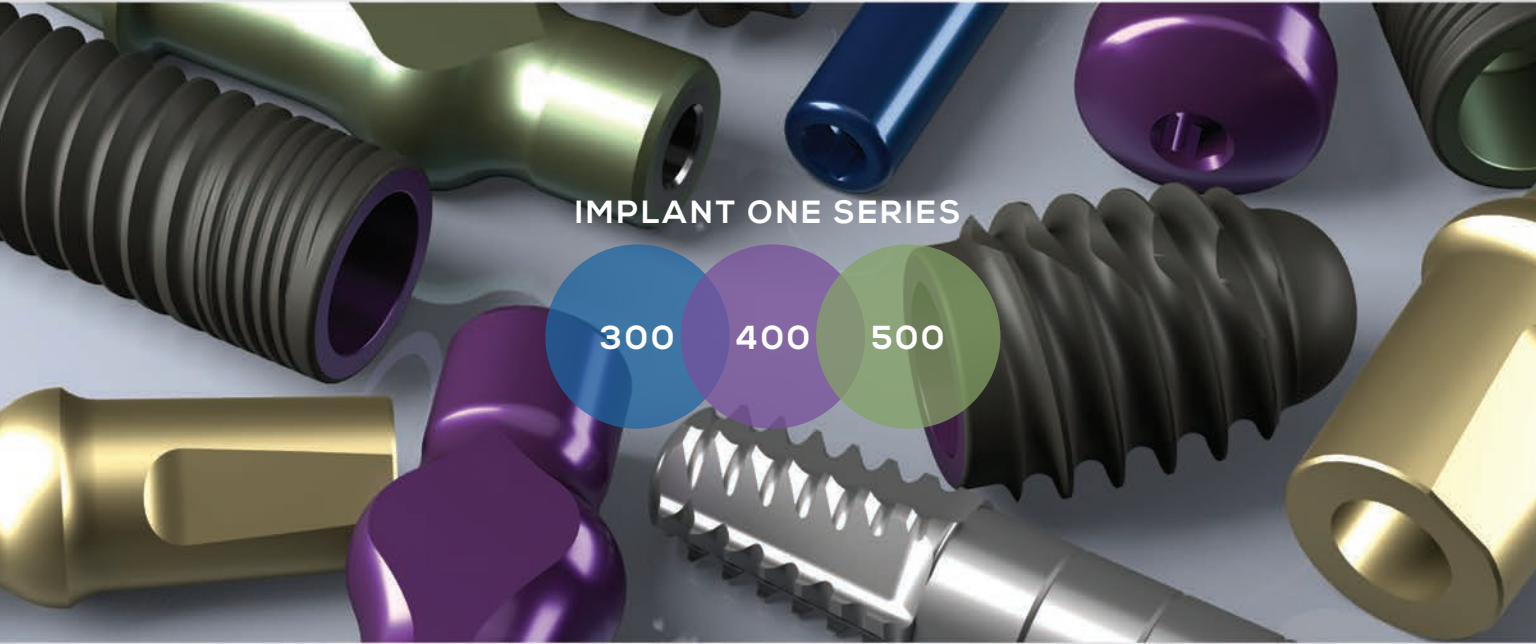

IMPLANT
LOGISTICS
INNOVATIVE DENTAL TECHNOLOGY

PRODUCT CATALOG



IMPLANT ONE SERIES

300

400

500



IMPLANT
— ONE —
PRECISION DENTAL IMPLANTS



implantlogistics.com | 844-383-8001



IMPLANT
— ONE —

A PRECISION DENTAL IMPLANT SYSTEM



ABOUT IMPLANT LOGISTICS:

Implant Logistics was founded by general dentist and implantologist, Dr. Leo Malin, in response to a need he saw for affordable US-based implant systems that would be robust, simple to use, preserve bone and give predictable results.

Implant Logistics provides implants, implant components and accessories that are designed to prevent the bone loss associated with most implant systems currently on the market. In addition, our implant systems are designed to be simple to use, to provide the full range of restorative options and are priced competitively.

Dr. Malin started delivering implant services in 1993 and in his quest for the best implants and components, he found that some of the implants manufactured in Europe that he felt were superior to the U.S. ones were simply not available to the US market. When the Morse tapered implants were introduced into the US they were significantly better than what was available in the U.S., however, Dr. Malin felt these systems could be improved and the cost of those systems was also prohibitive. He set about developing an improved implant system at a more affordable price. After much research and innovation, he set up manufacturing facilities in the U.S. and created the Implant One system of implants and components.

Implant Logistics continues to innovate and develop implants that are simple to use, give stable results and meet the needs of implant dentists.

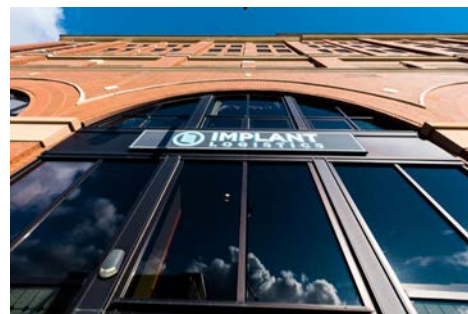



IMPLANT MANUFACTURING:

AMS Micromedical, LLC was formed in 2011 to focus specifically on the Medical Device and Dental Implant fields.

AMS Micromedical management, quality assurance and engineering personnel have upwards of 30 years experience each in their respective fields. They offer impressive capabilities and excellent customer service.

Micro-sized parts suitable for CNC Swiss machining are their specialty: dental implants and related components, complete surgical kits, surgical drills and instruments, catheter components and other precision machined devices.

AMS Micromedical also offers numerous secondary operation capabilities including laser marking, pad printing and assembly. Our equipment and software is state of the art, our personnel are highly trained and experienced, and our facility is ISO 13485:2003, ISO 9001:2008 FDA registered. Prototype or low quantity production runs are considered.



www.amsmicromedical.com

TABLE OF CONTENTS:

- About Implant LogisticsPage 1**
- Implant Manufacturing.....Page 2**
- Features and Benefits.....Page 4–5**
- ImplantsPage 7–9**
 - Standard Implants.....Page 8
 - Wide Implants.....Page 8
 - Implant Packaging FeaturesPage 9
- Implant Abutments Page 11–18**
 - Ti-Base Abutment..... Page 12
 - MUA, Straight..... Page 13
 - Multi-unit Abutment (MUA), Angled.....Page 14
 - Scan Body.....Page 15
 - Standard & Temporary Abutments Page 16
 - Ball Abutment.....Page 17
 - Positioner Denture Retaining Abutment..... Page 17
 - Wide Post & Straight Abutments Page 18
- Implant Accessories..... Page 19–22**
 - Healing CapsPage 20
 - Closed Tray Impression Post.....Page 21
 - Open Tray Impression Post.....Page 21
 - AnalogPage 21
 - MUA Accessories.....Page 22
- Surgical and Restorative Tools Page 23–30**
 - Surgical KitPage 24
 - Drill Kit.....Page 25
 - Restorative Kit.....Page 26
 - Bone Profiling Kit.....Page 27
 - Drills and Drill AccessoriesPage 28
 - Drivers.....Page 29
 - Carrier AdaptersPage 30
 - Bone Profilers and Guide Pins.....Page 30
 - Wrenches.....Page 30
 - Abutment Extractors.....Page 30
- Procedures Page 31–44**
 - Implant Surgical ProcedurePage 32–33
 - Bone Profiling Page 34
 - Closed Tray Impressions..... Page 35
 - Open Tray Impressions Page 36
 - Placement of Healing Cap..... Page 37
 - Placement of Abutment and Cement Retained Restoration Page 38
 - Placement of Multi-unit Abutment (MUA)..... Page 39
 - Placement of Positioner Denture Retaining Abutment..... Page 40
 - Placement of Ball Abutment and Restoration..... Page 41
 - Placement of Rhein83 Retentive Caps Page 42
 - Abutment Removal..... Page 43
 - Scan Body Procedure Page 44
- Information Sheets..... Page 45–48**
 - Intended Use of Surgical Kit Components Page 46
 - Direct Placement Implants..... Page 47
 - Carrier Features Page 47
 - Abutment Screw..... Page 48
- Implant One Glossary..... Page 49**



IMPLANT ONE FEATURES AND BENEFITS

MORSE TAPER CONNECTION FOR BONE AND TISSUE HEALTH

In implantology, bone and soft tissue health is the biggest determinate of successful implant integration, the aesthetics of the restoration, and the longevity of the implant. For this reason, at the core of the Implant One system is a 6° Morse Taper implant-abutment connection which ensures strong, enduring, bacteria-free implant experiences for patients.



Morse Tapers are widely used in applications where strong joints between mechanical components are paramount. They produce tight and secure connections that are resistant to multi-directional forces, like those that dental implants are routinely subjected to.

The radiographs below demonstrate the key difference between a standard hex implant-abutment connection and a Morse Taper connection when lateral forces are applied. The Morse Taper remains tightly closed to bacteria as the force is applied, but the hex does not.

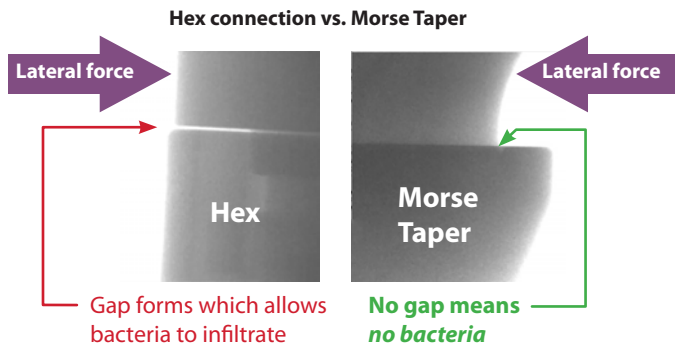

.050" HEX SCREW
DRAWS THE
CONNECTION
TIGHTLY CLOSED

GOLD
ANODIZATION
FOR BETTER
CROWN
AESTHETICS

AGGRESSIVE
THREADS FOR
PRIMARY STABILITY



SUB-CRESTAL PLACEMENT

The practical elimination of bacteria infiltration by the Implant One design allows the implants to be placed at or below the crest of bone which helps reduce the stress applied to the cortical plate, and prevent tissue and bone die-back. This means better integration, better aesthetics and an implant that can last the lifetime of the patient.

All Implant One implants can and should be placed crestal or sub-crestal in order to realize the full advantages of the system.





THREAD DESIGN

The Implant One system provides clinicians with two thread variants, Standard and Wide, so that optimum primary stability can be attained in every clinical case.

STANDARD THREAD IMPLANT

Suitable for all bone density types, the Standard Thread implants feature aggressive, self-tapping threads for increased initial stability and **Microthreads** to reduce pressure on the thin cortical plates, lessening the risk of pressure necrosis.



WIDE THREAD IMPLANT

The Wide Thread is ideal for immediate implant placement in extraction sites or in cases with poor bone density. **The larger surface area of the threads** provide maximum primary stability.

IMPLANT ONE ABUTMENTS



Implant One offers a complete line of abutments for individual, full-arch fixed, and full-arch removable restorations. All abutments feature Implant One's uniquely strong Morse Taper implant-abutment connection. This connection is so strong that it

would be impossible to remove the abutments, if ever necessary, if they did not include **self-extraction features**.

See all Implant One abutments beginning on page 11.



EXTRACTOR TOOL

INTERNAL THREADS ENABLE EXTRACTOR TOOL TO RELEASE THE GRIP OF THE MORSE TAPER

See page 43 for more details.

SERIES COLOR IDENTIFIERS

For ease of use, Implant One implants and restorative components are anodized with their series' color codes.

- SERIES 300 = BLUE
- SERIES 400 = PURPLE
- SERIES 500 = LIGHT GREEN

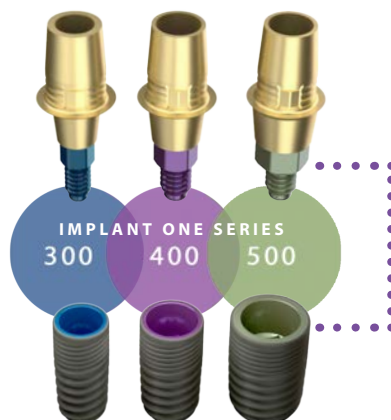

MATCHING ABUTMENT AND IMPLANT SERIES COLOR



IMPLANT

— ONE —



STANDARD AND WIDE **IMPLANTS:**



300

400

500

STANDARD IMPLANTS:

The Standard Thread implants feature aggressive, self-tapping threads for increased initial stability and “Microthreads” to reduce pressure on the thin cortical plates, lessening the risk of pressure necrosis. By varying the osteotomy diameter, this implant can be placed in bone of any density.



	300 series	400 series	500 series		
	←----- DIAMETER -----→				
LENGTH	3.5 mm	4.0 mm	4.5 mm	5.0 mm	5.5 mm
8 mm	IR3-3508-00	IR4-4008-00	IR4-4508-00	IR5-5008-00	IR5-5508-00
10 mm	IR3-3510-00	IR4-4010-00	IR4-4510-00	IR5-5010-00	IR5-5510-00
12 mm	IR3-3512-00	IR4-4012-00	IR4-4512-00	IR5-5012-00	IR5-5512-00
14 mm	IR3-3514-00	IR4-4014-00	IR4-4514-00	IR5-5014-00	IR5-5514-00



WIDE THREAD IMPLANTS:

The Wide Thread implant is designed for maximum primary stability when immediate implant placement in extraction sites is desired or in cases with poor bone density. Wide Thread implants should not be placed in dense bone.

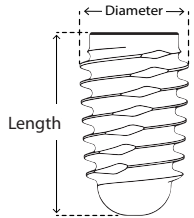

	300 series	400 series	500 series	
	←----- DIAMETER -----→			
LENGTH	4.1 mm	4.5 mm	5.5 mm	6.5 mm
8 mm	IW3-4108-00	IW3-4508-00	IW4-5508-00	IW5-6508-00
10 mm	IW3-4110-00	IW3-4510-00	IW4-5510-00	IW5-6510-00
12 mm	IW3-4112-00	IW3-4512-00	IW4-5512-00	
14 mm	IW3-4114-00	IW3-4514-00		

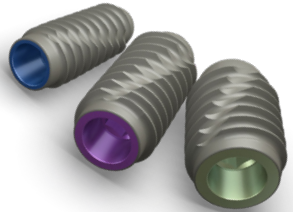

Common Features of all Implant One implants

- Optimized for bone health & aesthetics
- Self-tapping external threads
- Morse Taper implant-abutment connection: tight and bacteria-free
- Sub-crestal placement recommended

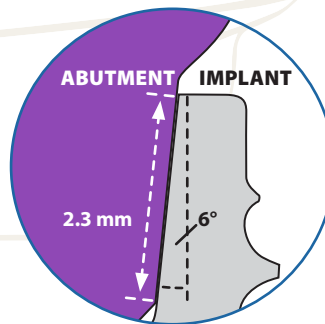

Internal Implant-Abutment Connection Details

Specifications

Material: 6AL4V E.L.I. Titanium
 Lengths (mm): 8, 10, 12, 14
 Diameters (mm): 3.5, 4.0, 4.1, 4.5, 5.0, 5.5, 6.5
 Internal Connection: 6° Morse Taper
 Connection Length: 2.3 mm
 Cover screw included





IMPLANT PACKAGING FEATURES:

Direct-placement implants



SIMPLIFIED PACKAGING



IMPLANT DRIVER SNAPS DIRECTLY INTO IMPLANT



IMPLANT MAY BE DRIVEN TO FULL DEPTH IMMEDIATELY



EASY ACCESS TO THE COVER SCREW

See procedure on page 32

Implants with carriers



PACKAGE WITH COVER



ADAPTER SNAPS ONTO CARRIER WHILE REMAINING STERILE

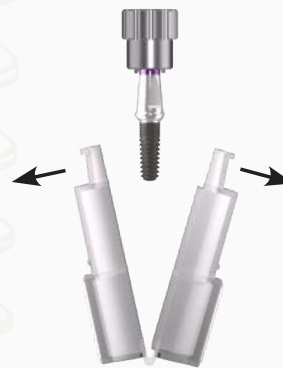

PACKAGING OPENS TO RELEASE IMPLANT AND CARRIER



COVER SCREW IS PACKAGED IN THE COVER

See procedure on page 32



IMPLANT

— O N E —

IMPLANT **ABUTMENTS**:

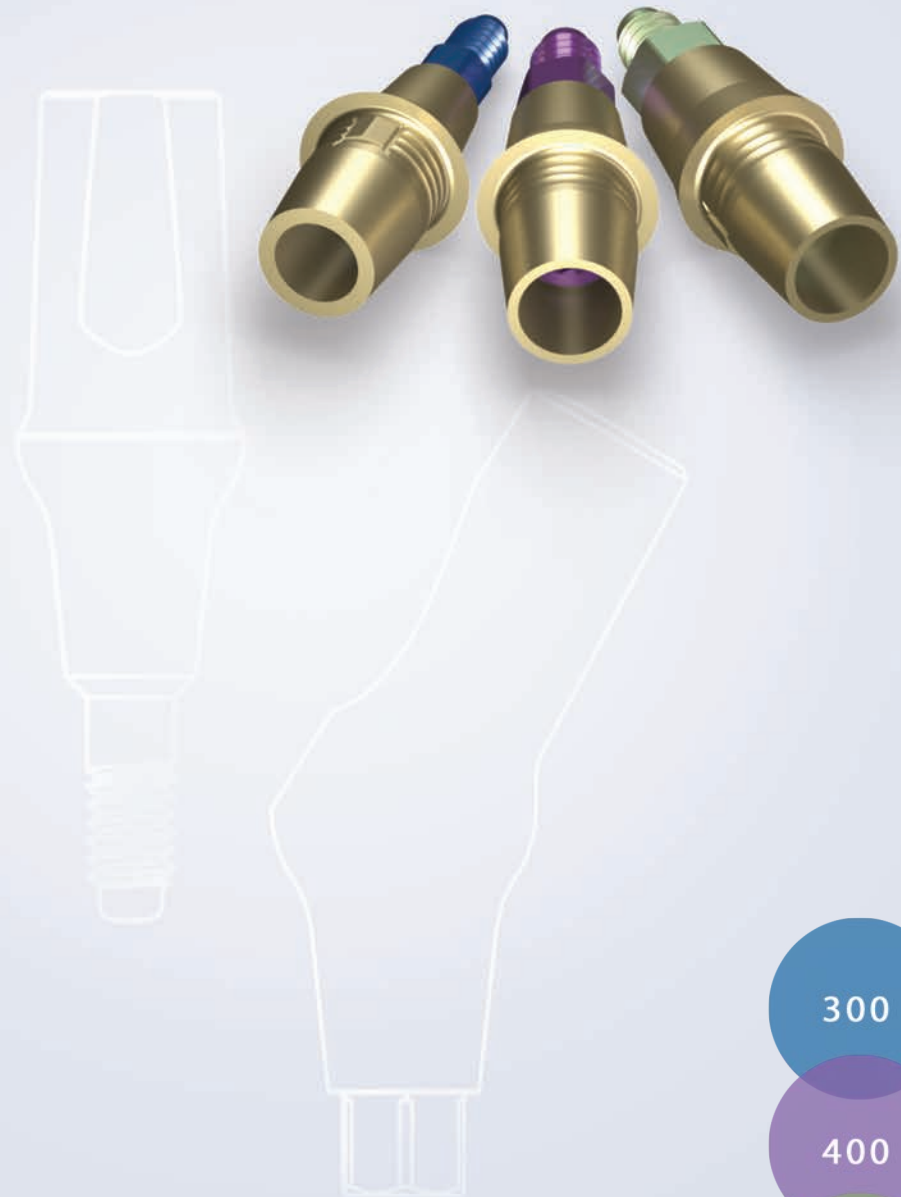

300

400

500

TI-BASE ABUTMENT

Ti-Base abutments are compatible with CAD-CAM systems. They are made of titanium and designed for all ceramic restorations.



PLATFORM HEIGHT	300 series	400 series	500 series
0.5 mm	ATB-0305-01	ATB-0405-00	ATB-0505-00
1.5 mm	ATB-0315-01	ATB-0415-00	ATB-0515-00
2.5 mm	ATB-0325-01	ATB-0425-00	ATB-0525-00

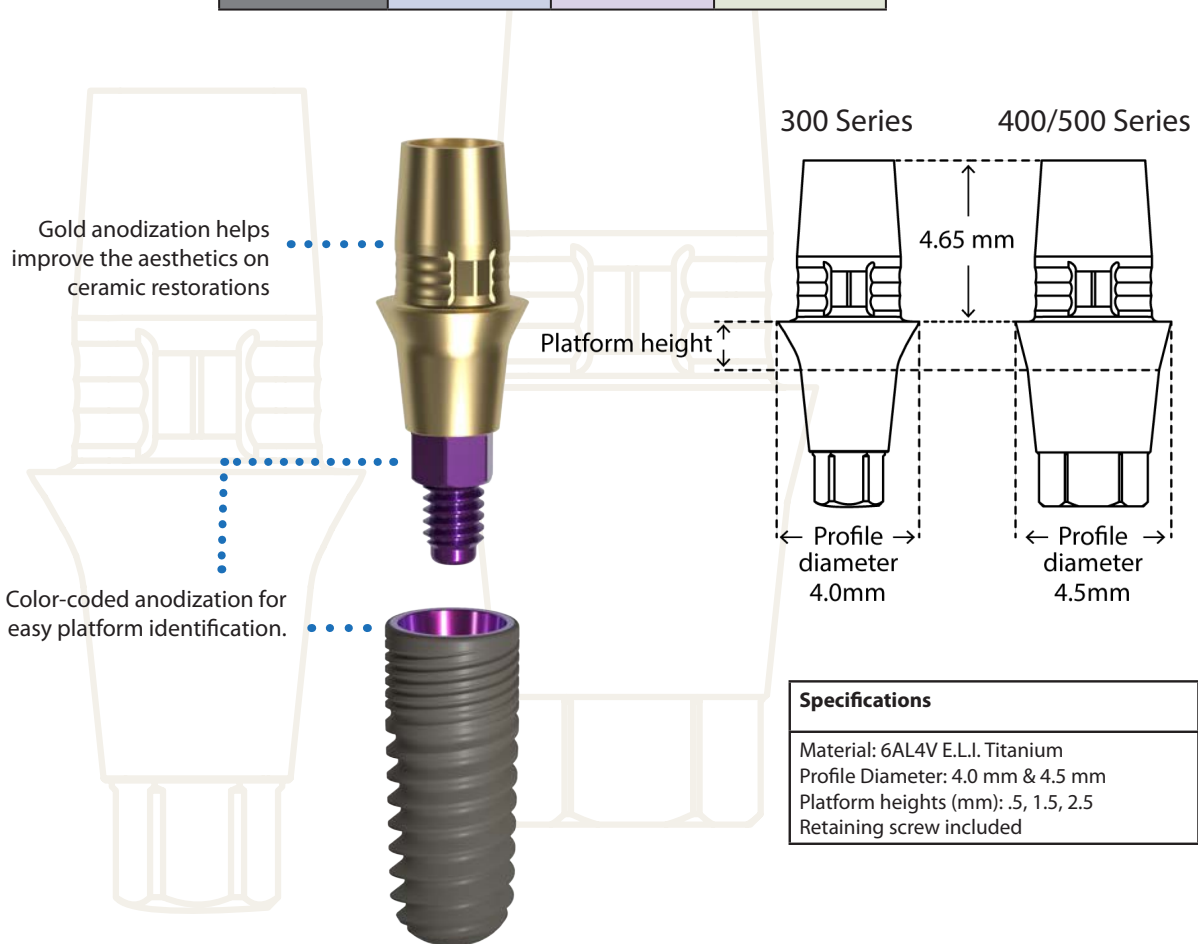



MULTI-UNIT ABUTMENT (MUA), STRAIGHT

Used to secure multi-unit screw-retained prosthetics. Straight MUAs are self-retaining with the threaded shank on the abutment.



PLATFORM HEIGHT	300 series	400 series	500 series
0.5 mm	MUA-0305-00	MUA-0405-00	MUA-0505-00
1 mm	MUA-0310-00	MUA-0410-00	MUA-0510-00
2 mm	MUA-0320-00	MUA-0420-00	MUA-0520-00
3 mm	MUA-0330-00	MUA-0430-00	MUA-0530-00
4 mm	MUA-0340-00	MUA-0440-00	MUA-0540-00
5 mm	MUA-0350-00	MUA-0450-00	MUA-0550-00



Use the DEH-0910-32 MUA Driver to install.



Anodization for improved aesthetics.

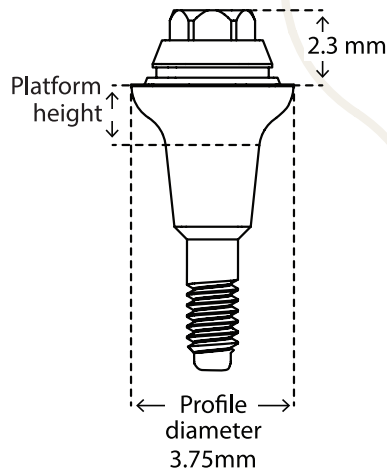

Specifications
Material: 6AL4V E.L.I. Titanium
Profile Diameter: 3.75 mm
Platform Heights (mm): .5, 1, 2, 3, 4, 5
Torque: 20 Ncm (300 Series)
30 Ncm (400 & 500 Series)

MUA Accessories

See page 22 for details.

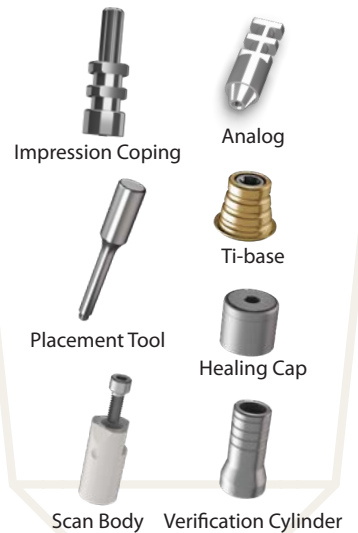

MULTI-UNIT ABUTMENT (MUA), ANGLED

Use Angled MUAs for paralleling abutments in non-aligned implants. The Implant One MUA line has 17° and 30° angles available.



17° angle



30° angle

300 series	400 series	500 series	Angle	Platform height	Minimum platform height	Maximum platform height
			A	B (mm)	C (mm)	D (mm)
MUA-0325-17	MUA-0425-17	MUA-0525-17	17°	2.5	1.79	3.12
MUA-0335-17	MUA-0435-17	MUA-0535-17	17°	3.5	2.79	4.12
MUA-0325-30	MUA-0425-30	MUA-0525-30	30°	2.5	1.33	3.64
MUA-0335-30	MUA-0435-30	MUA-0535-30	30°	3.5	2.33	4.12

Install with an .050" driver.



(Cut-away view)

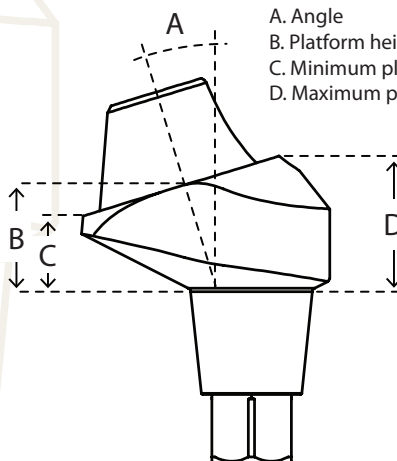

A. Angle
B. Platform height
C. Minimum platform height
D. Maximum platform height

Specifications
Platform Heights: 2.5 mm & 3.5 mm
Angles: 17° & 30°

MUA Accessories

See page 22 for details.





SCAN BODY

The Implant One Scan Body is designed with specialized geometry that helps CAD software pinpoint the exact location of an Implant One implant, its timing, and its relationship to the arch form.

	300 series	400 series	500 series
PART #	ASC-0300-00	ASC-0400-00	ASC-0500-00
PROFILE DIAMETER	3.5 mm	4.0 mm	4.0 mm

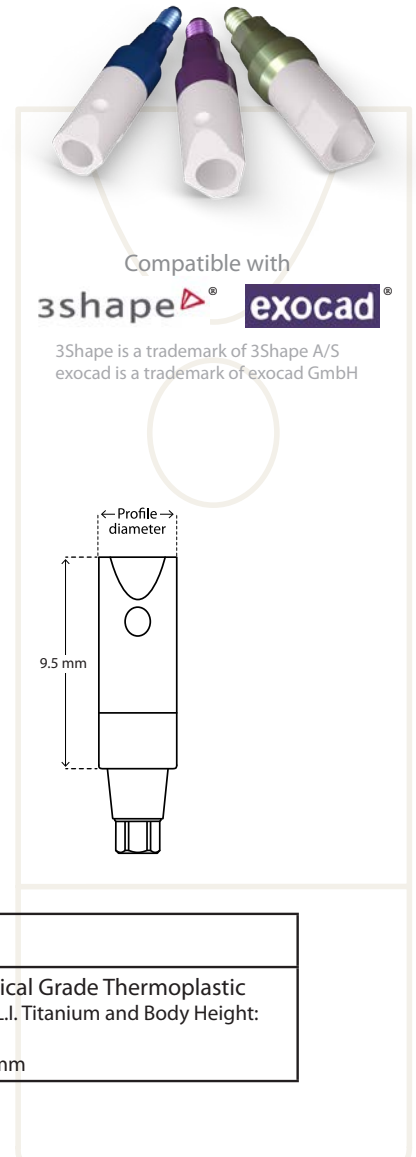

Lower half made of titanium for durability and a temporary, yet secure, connection to the implant

Top half designed to maximize scan accuracy



PEEK Medical Grade Thermoplastic is easily imaged with a scanner

Proper seating can be radiographically verified – a must for sub-crestal implant placement.

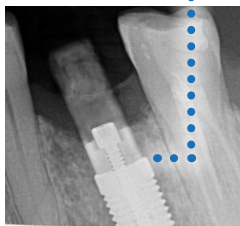

Specifications
Scannable Material: PEEK Medical Grade Thermoplastic
Connection Material: 6AL4V E.L.I. Titanium and Body Height: 9.5 mm
Profile Diameter: 3.5 mm or 4 mm

MUA Scan Body

Provides the same scanner visibility as above for Multi-Unit Abutments.

MUA-0345-SB

Made of PEEK Medical Grade Thermoplastic

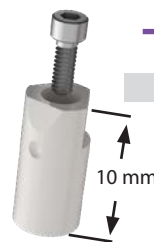

Requires a MUA Accessory Torque Driver



TDB-0060-24

TDB-0060-28

STANDARD ABUTMENT

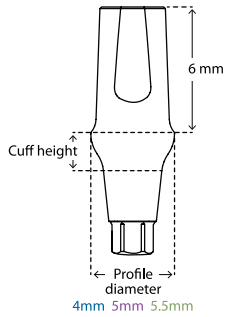

Standard abutments have a hexagonal male end for abutment orientation, are screw retained and may be modified by the dental laboratory. Standard abutments are offered straight or with a 15° angle.

Specifications
Material: 6AL4V E.L.I. Titanium
Profile Diameters (mm): 4, 5, 5.5
Cuff heights (mm): .5, 1, 2, 3, 4, 5
Angles: 0°, 15°

300 series		
HEIGHT	0°angle	15°angle
0.5 mm	APT-0305-00	APT-0305-15
1 mm	APT-0310-00	APT-0310-15
2 mm	APT-0320-00	APT-0320-15
3 mm	APT-0330-00	APT-0330-15
4 mm	APT-0340-00	APT-0340-15
5 mm	APT-0350-00	APT-0350-15
PROFILE DIAMETER	4 mm	

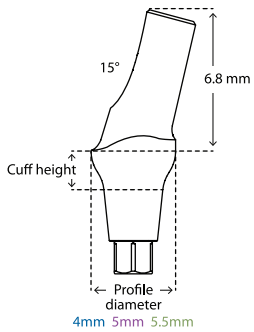
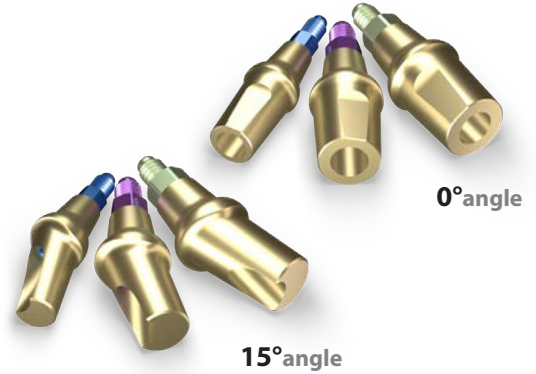

400 series		
HEIGHT	0°angle	15°angle
0.5 mm	APT-0405-00	
1 mm	APT-0410-00	APT-0410-15
2 mm	APT-0420-00	APT-0420-15
3 mm	APT-0430-00	APT-0430-15
4 mm	APT-0440-00	APT-0440-15
5 mm	APT-0450-00	
PROFILE DIAMETER	5 mm	

500 series		
HEIGHT	0°angle	15°angle
0.5 mm	APT-0505-00	
1 mm	APT-0510-00	APT-0510-15
2 mm	APT-0520-00	APT-0520-15
3 mm	APT-0530-00	APT-0530-15
4 mm	APT-0540-00	APT-0540-15
5 mm	APT-0550-00	
PROFILE DIAMETER	5.5 mm	

TEMPORARY ABUTMENT

Temporary abutments are designed to be temporarily seated with temporary attachment or crown while the final restoration is being made.

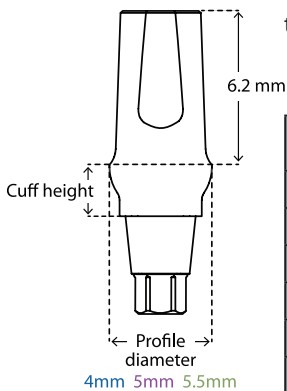

CUFF HEIGHT	300 series	400 series	500 series
0.5 mm	ATM-0305-00	ATM-0405-00	ATM-0505-00
1 mm	ATM-0310-00	ATM-0410-00	ATM-0510-00
2 mm	ATM-0320-00	ATM-0420-00	ATM-0520-00
3 mm	ATM-0330-00	ATM-0430-00	ATM-0530-00
4 mm	ATM-0340-00	ATM-0440-00	ATM-0540-00
5 mm	ATM-0350-00	ATM-0450-00	ATM-0550-00
PROFILE DIAMETER	4 mm	5 mm	5.5 mm

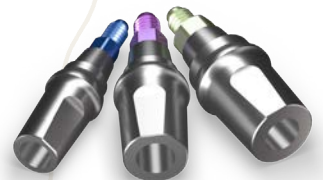

Specifications
Material: 6AL4V E.L.I. Titanium
Profile Diameters (mm): 4, 5, 5.5
Cuff heights (mm): .5, 1, 2, 3, 4, 5





BALL ABUTMENT

Ball abutments are a one piece abutments without orientation used for implant-retained soft tissue supported restorations. Using Rhein83 (rhein83usa.com) 2.5mm attachments, ball abutments provide optimal retention for every individual patient.

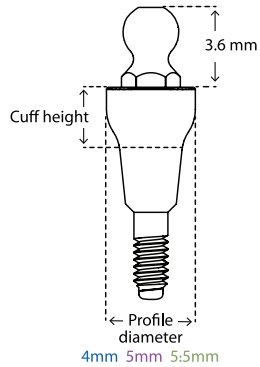

CUFF HEIGHT	300 series	400 series	500 series
2 mm	ABL-0320-00	ABL-0420-00	ABL-0520-00
3 mm	ABL-0330-00	ABL-0430-00	ABL-0530-00
4 mm	ABL-0340-00	ABL-0440-00	ABL-0540-00
5 mm	ABL-0350-00	ABL-0450-00	ABL-0550-00
PROFILE DIAMETER	4 mm	5 mm	5.5 mm



Ball compatible with Rhein83 2.5mm components. See page 42.

Use the Ball Abutment Driver to attach to the implant



DEH-0000-00

Specifications
Material: 6AL4V E.L.I. Titanium
Profile Diameters (mm): 4, 5, 5.5
Cuff heights (mm): 2, 3, 4, 5
Maximum torque: 20Ncm 300 Series 30Ncm 400 & 500 Series

POSITIONER DENTURE RETAINING ABUTMENT

Abutments for retaining overdenture restorations. Retention inserts sold separately.

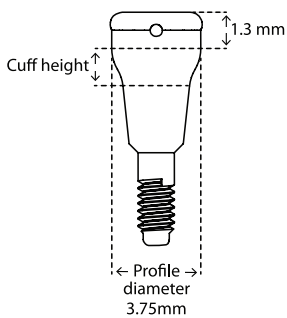

CUFF HEIGHT	300 series	400 series	500 series
0.5 mm	ALR-0305-00	ALR-0405-00	ALR-0505-00
1 mm	ALR-0310-00	ALR-0410-00	ALR-0510-00
2 mm	ALR-0320-00	ALR-0420-00	ALR-0520-00
3 mm	ALR-0330-00	ALR-0430-00	ALR-0530-00
4 mm	ALR-0340-00	ALR-0440-00	ALR-0540-00
5 mm	ALR-0350-00	ALR-0450-00	ALR-0550-00
6 mm	ALR-0360-00	ALR-0460-00	ALR-0560-00
7 mm	ALR-0370-00	ALR-0470-00	ALR-0570-00



Gold anodization for superior aesthetics.



DLR-0345-00

Use the Positioner Driver to attach to the implant.

Specifications
Material: 6AL4V E.L.I. Titanium
Profile Diameter: 3.75 mm
Cuff heights (mm): .5, 1, 2, 3, 4, 5, 6, 7
Maximum torque: 20Ncm 300 Series 30Ncm 400 & 500 Series



WIDE POST ABUTMENT

Wide Post Abutments are designed for being manually customized by dental laboratories for patient specific abutments.

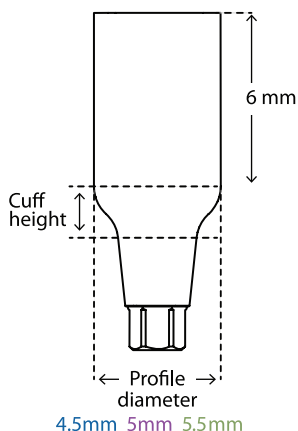
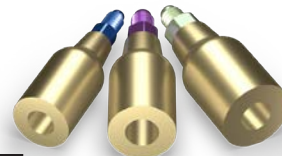

CUFF HEIGHT	300 series	400 series	500 series
0.5 mm	AWP-0305-00	AWP-0405-00	AWP-0505-00
1 mm	AWP-0310-00	AWP-0410-00	AWP-0510-00
2 mm	AWP-0320-00	AWP-0420-00	AWP-0520-00
3 mm	AWP-0330-00	AWP-0430-00	AWP-0530-00
4 mm	AWP-0340-00	AWP-0440-00	AWP-0540-00
5 mm	AWP-0350-00	AWP-0450-00	AWP-0550-00
PROFILE DIAMETER	4.5 mm	5 mm	5.5 mm

Specifications
Material: 6AL4V E.L.I. Titanium
Profile Diameters: 4.5 mm, 5 mm, 5.5 mm
Cuff heights (mm): .5, 1, 2, 3, 4, 5

STRAIGHT ABUTMENT

Straight abutments are ideal for placement in narrow spacing areas. The top of the abutment is thinner than on the standard abutment. Straight abutments can be prepped and fitted with a custom crown.

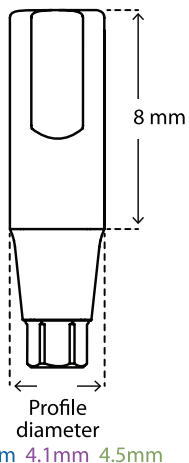
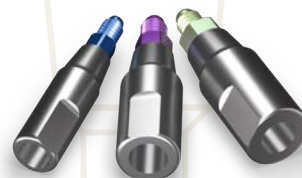

300 series	400 series	500 series	
AST-0300-00	AST-0400-00	AST-0500-00	
3.1 mm	4.1 mm	4.5 mm	PROFILE Ø

Specifications
Material: 6AL4V E.L.I. Titanium
Profile Diameters: 3.1 mm , 4.1 mm, 4.5 mm
Height from top of implant to top of abutment: 8 mm
Maximum torque: 20Ncm 300 Series
25Ncm 400 & 500 Series



IMPLANT **ACCESSORIES:**



- 300
- 400
- 500

IMPLANT ONE HEALING CAPS *(Healing Abutments, Tissue Formers)*

Used for tissue forming during the gingival healing period.

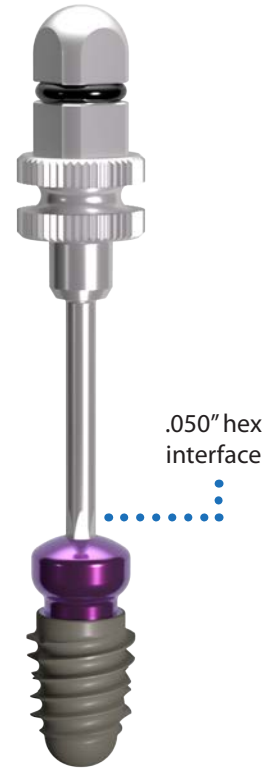
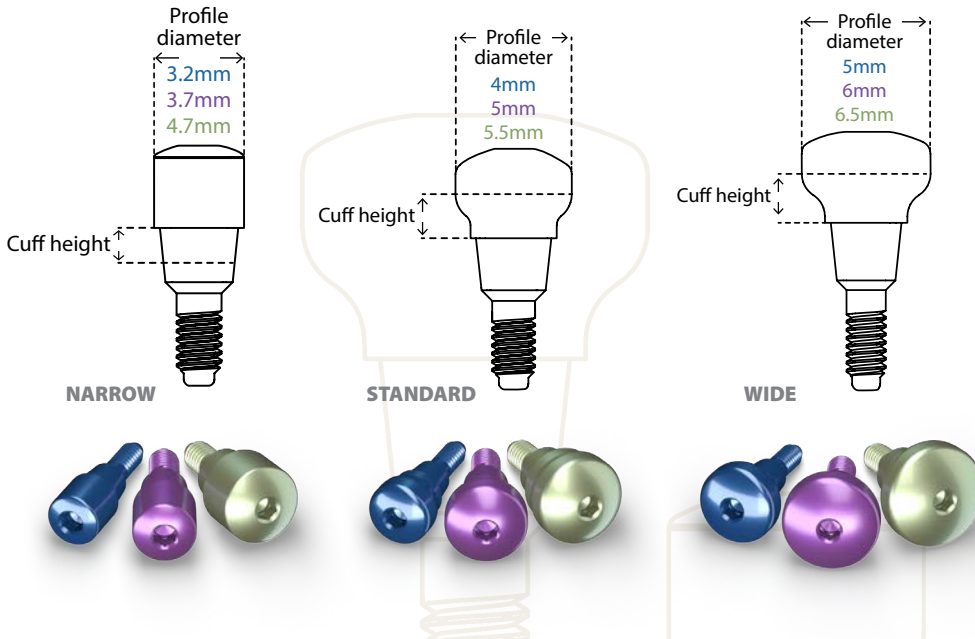

Specifications
Material: 6AL4V E.L.I. Titanium
Profile Diameter: 3.2 mm – 6.5 mm
Cuff Heights (mm): 1, 2, 3, 4, 5, 6, 7
Maximum Torque: 6 Ncm

Healing Cap 300 series			
CUFF HEIGHT	NARROW	STANDARD	WIDE
1 mm	HCN-0310-00	HCS-0310-00	
2 mm	HCN-0320-00		
3 mm	HCN-0330-00	HCS-0330-00	HCW-0330-00
5 mm	HCN-0350-00	HCS-0350-00	HCW-0350-00
7 mm	HCN-0370-00		
PROFILE DIAMETER	3.2 mm	4 mm	5 mm

Healing Cap 400 series			
CUFF HEIGHT	NARROW	STANDARD	WIDE
1 mm	HCN-0410-00	HCS-0410-00	
2 mm	HCN-0420-00		
3 mm	HCN-0430-00	HCS-0430-00	HCW-0430-00
5 mm	HCN-0450-00	HCS-0450-00	HCW-0450-00
7 mm	HCN-0470-00		
PROFILE DIAMETER	3.7 mm	5 mm	6 mm

Healing Cap 500 series			
CUFF HEIGHT	NARROW	STANDARD	WIDE
1 mm	HCN-0510-00	HCS-0510-00	
2 mm	HCN-0520-00		
3 mm	HCN-0530-00	HCS-0530-00	HCW-0530-00
5 mm	HCN-0550-00	HCS-0550-00	HCW-0550-00
7 mm	HCN-0570-00		
PROFILE DIAMETER	4.7 mm	5.5 mm	6.5 mm



CLOSED TRAY IMPRESSION POST *(Impression Pin, Impression Coping)*

Used to make a closed tray impression.



Plastic cap prevents impression material from entering access hole. It remains in the impression when post is removed, which provides a firm seat for the coping after curing.

Flat face will be parallel with implant hex flat when properly seated.

WHEN FULLY SEATED, POST WILL SIT FLUSH ON TOP OF THE IMPLANT.



300 series	400 series	500 series
IPC-0300-00	IPC-0400-00	IPC-0500-00

Specifications
Material: 6AL4V E.L.I. Titanium
Profile Diameter: 3.5 mm

Replacement Caps For Closed Tray Impression Posts

Pack of 10
IPC-1 X 10

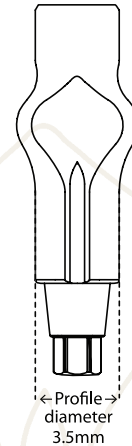

OPEN TRAY IMPRESSION POST

Two-piece post used to make an open tray impression.

Center pin secures post to implant.

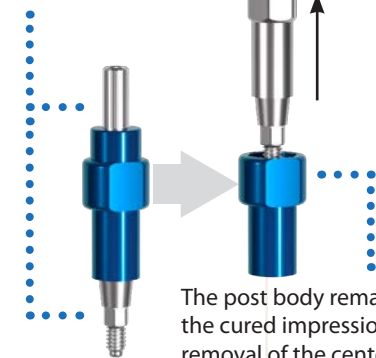

The post body remains lodged in the cured impression material after removal of the center pin.



	300 series	400 series	500 series
	IPO-0300-00	IPO-0400-00	IPO-0500-00
PROFILE Ø	5.3 mm	5.3 mm	6.3 mm

Specifications
Material: 6AL4V E.L.I. Titanium
Profile Diameter: 5.3 mm – 6.3 mm

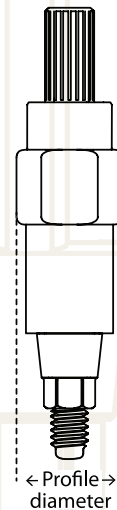

ANALOG

Used in the dental laboratory to represent the implant connection. Suitable for both digital and traditional model workflows.



	300 series	400 series	500 series
	ALG-0300-09	ALG-0400-09	ALG-0500-09
PROFILE Ø	3.5 mm	4 mm	4.7 mm

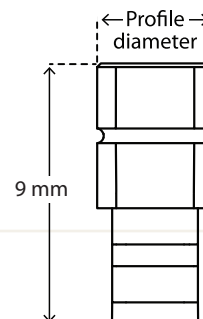

MUA ACCESSORIES

FOR ALL SERIES 300, 400 & 500 MULTI-UNIT ABUTMENTS



Healing Cap

Placed on top of Multi-Unit Abutments during the gingival healing period.

MUA-0345-HC



Placement Tool

Assists placement of all angled Multi-Unit Abutments.

MUA-0345-PT



Open Tray Impression Coping

MUA-0345-IP



Closed Tray Impression Coping

IPC-0345-00



Analog

Used in the dental laboratory to represent the MUA connection. New design includes a gingival mask retention groove.

ALG-0345-00



Digital Scan Body

Attaches to the MUA for digital optical scans.

MUA-0345-SB



Ti-base

Used by labs to make screw-retained connections to MUA.

MUA-0345-TB



Burnout Sleeve

For analog prosthesis production.

MUA-0345-BN



Verification Cylinder

Used for temporary restorations and verification jigs.

MUA-0345-VC

REQUIRED FOR THESE ACCESSORIES



TDB-0060-24 TDB-0060-28

Accessory Torque Drivers

#6 Hexalobular Ball

SURGICAL & RESTORATIVE **TOOLS:**

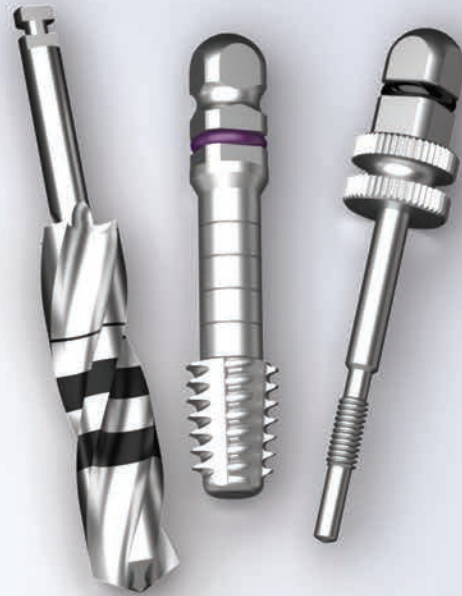
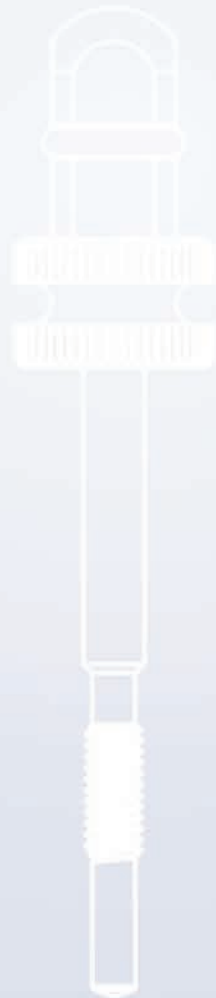

300

400

500

SURGICAL KIT

KIT-SUIN-00

For use with
300-400-500 Series

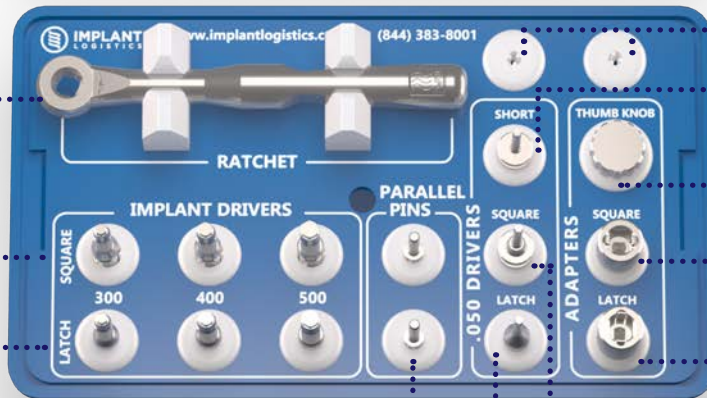

Ratchet

Spare tool slots



Knurled Tapered
.050 Driver
HDT-5050-02



Thumb Knob
ADP-THMK-00



Square Ratchet Adapter
ADP-RCHT-00



Hand Piece Adapter
ADP-HNDP-00

Implant Drivers (latch style)



DIH-0310-00

DIH-0410-00

DIH-0510-00

300

400

500

Implant Drivers (ratchet style)



DIM-0310-00

DIM-0410-00

DIM-0510-00



Parallel Pins
PLP-2030-00

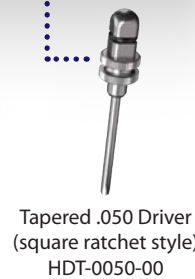

Tapered .050 Driver
(square ratchet style)
HDT-0050-00

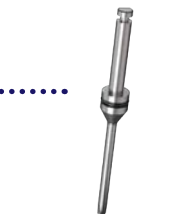

Tapered .050 Driver
(latch style)
HDT-0050-01



DRILL KIT

KIT-SUDR-00

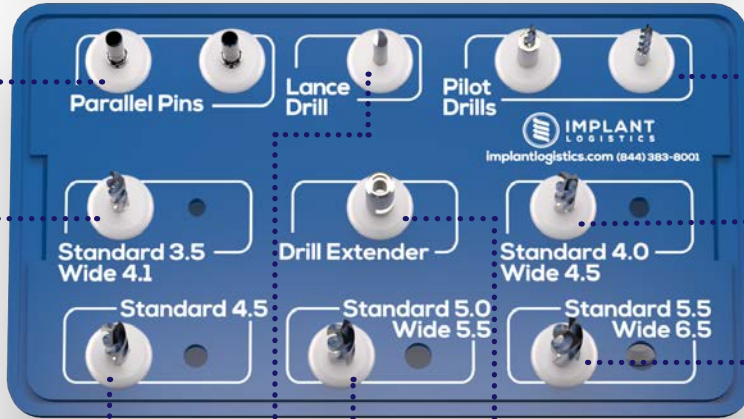

Pilot Drills



DRS-2008-00 DRS-2015-00

These Implants:



Wide 4.5 mm



Standard 4.0 mm

Use:



DRS-3520-00

These Implants:



Wide 6.5 mm



Standard 5.5 mm

Use:



DRS-5020-00

Parallel Pins

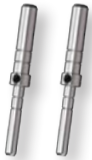

PLP-2030-00

These Implants:



Wide 4.1 mm



Standard 3.5 mm

Use:



DRS-3020-00

Lance Drill



DRS-LANC-00

These Implants:



Wide 5.5 mm



Standard 5.0 mm

Use:



DRS-4520-00

Drill Extender



DEX-6200-00

This Implant:



Standard 4.5 mm

Uses:



DRS-4020-00

RESTORATIVE KIT

KIT-REIN-00

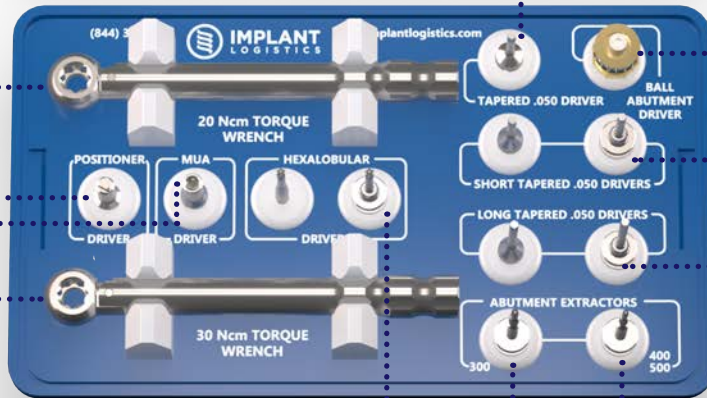

20 Ncm Torque Wrench for Series 300 Abutments
TWB-3000-20



Positioner Denture Retaining Abutment Driver DLR-0345-00



MUA Driver DEH-0910-32

30 Ncm Torque Wrench for Series 400 & 500 Abutments
TWB-4500-30



Knurled Tapered .050 Driver
HDT-5050-02



Ball Abutment Driver
DEH-0000-00

Hexalobular Drivers for MUA attachments



TDB-0060-24 TDB-0060-28

Short Tapered .050 Drivers



HDT-0050-50



HDT-0050-51

Long Tapered .050 Drivers



HDT-0050-01



HDT-0050-00

Abutment Extractors



EXT-0080-00 for Series 300 abutments



EXT-0172-00 for Series 400 & 500 abutments



BONE PROFILING KIT

KIT-BOPR-00

Compatible with all
Implant One Series

The Implant One Bone Profiler Tools aid in uncovering an implant after the healing period and prior to restoration.

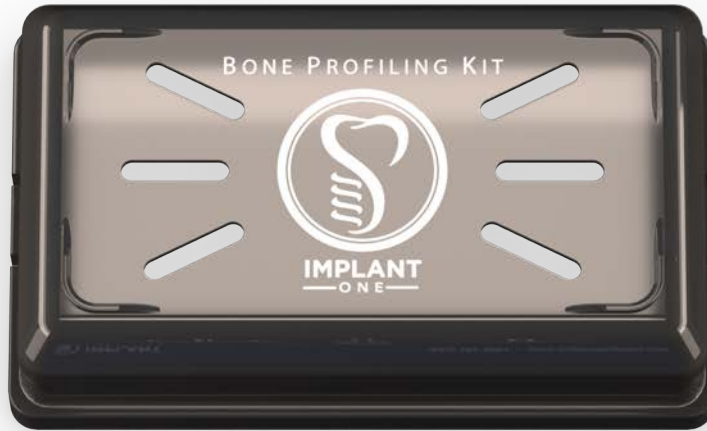

Drill Extender



DEX-6200-00

Bone Profilers



BP100
3.5mm

BP200
4.5mm

BP300
5.6mm

Guide Pins



GP100
Series 100

GP200
Series 200

GP300
Series 300

GP400
Series 400

GP500
Series 500



DRILLS

3-fluted drills engineered for efficiency and bone health.

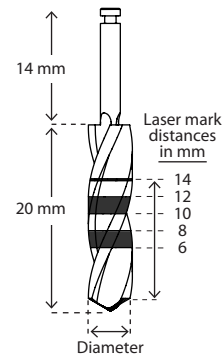
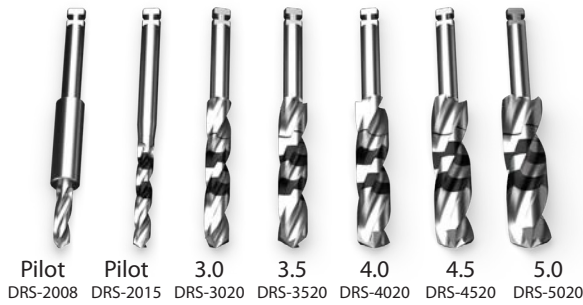

*-00" part # suffixes omitted in caption above

IMPLANT-DRILL PAIRING CHARTS

Recommended final drills for Implant One implants

DRILL	STANDARD IMPLANTS			WIDE IMPLANTS		
	300 series	400 series	500 series	300 series	400 series	500 series
	IMPLANT DIAMETER (mm)					
DRS-3020-00 (3.0mm)	3.5			4.1		
DRS-3520-00 (3.5mm)		4.0		4.5		
DRS-4020-00 (4.0mm)		4.5				
DRS-4520-00 (4.5mm)			5.0		5.5	
DRS-5020-00 (5.0mm)			5.5			6.5

DRILL ACCESSORIES

Drill Extender Extends reach of drill by 17 mm.



DEX-6200-00

Lance Drill Used to create a purchase at the implant site.



DRS-LANC-00

Parallel Pin Used for angulation verification of osteotomies.



PLP-2030-00



IMPLANT DRIVERS

Used to drive Implant One implants to final depth. PEEK insert facilitates placement of implants directly from packaging. See page 47 for more information.

DRIVER	300 series	400 series	500 series
Latch Style	DIH-0310-00	DIH-0410-00	DIH-0510-00
Ratchet Style	DIM-0310-00	DIM-0410-00	DIM-0510-00



Latch Style

Ratchet Style

ABUTMENT DRIVERS

MUA Driver

Used for seating MUA.



DEH-0910-32

MUA Accessory Torque Drivers

#6 hexalobular ball, required for MUA accessories.



TDB-0060-24

TDB-0060-28

Positioner Driver

For securing Positioner Denture Retaining Abutments.



DLR-0345-00

Ball Abutment Driver

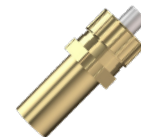

DEH-0000-00

.050" DRIVERS

Used to replace and remove cover screws, healing caps and most abutments.



Latch, Tapered
HDT-0050-S1

Ratchet, Tapered
HDT-0050-S0

Knurled, Tapered
HDT-5050-02

Latch, Straight
HDS-0050-01

Latch, Tapered, Long
HDT-0050-01

Ratchet, Tapered, Long
HDT-0050-00

Ratchet, Straight
HDS-0050-00

CARRIER ADAPTERS

Used to transfer implants with carriers into osteotomies. See page 47 for more information.

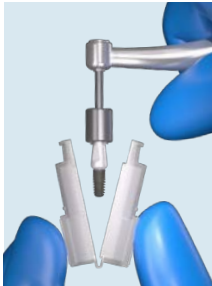

Ratchet Adapter



ADP-RCHT-00

Hand Piece Adapter



ADP-HNDP-00

Thumb Knob Adapter



ADP-THMK-00

BONE PROFILERS & GUIDE PINS

Guide pins guide the bone profilers in the proper orientation and stop them at the correct depth. Also available for Series 100 and 200.



GP300

GP400

GP500

Bone Profilers safely remove soft and hard tissue that has grown over the top of the implant during integration, thus allowing abutments to be fully seated.

BP100 BP200 BP300



3.5mm

4.5mm

5.6mm

WRENCHES

Ratchet

Multi-use manual ratchet.



RWA-0000-00

Breakaway Torque Wrenches

For installing abutments. The heads disengage when the pre-calibrated torques are met.



300

TWB-3000-20 Calibrated to 20 Ncm for use with Implant One 300 Series abutments.

400 500

TWB-4500-30 Calibrated to 30 Ncm for use with Implant One 400 and 500 Series abutments.

ABUTMENT EXTRACTORS

Specially-designed extractors release the Morse taper implant-abutment connection to allow removal and replacement of Implant One abutments.

See page 41 for procedure information.



300

EXT-0080-00 for Implant One 300 Series abutments.

400 500

EXT-0172-00 for Implant One 400 and 500 Series abutments.

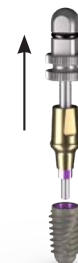

PROCEDURES:



IMPLANT SURGICAL PROCEDURE

IMPLANT ONE BONE PROFILER TOOL

CLOSED TRAY IMPRESSIONS

OPEN TRAY IMPRESSIONS

PLACEMENT OF HEALING CAP

**PLACEMENT OF ABUTMENT AND CEMENT
RETAINED RESTORATION**

PLACEMENT OF MULTI-UNIT ABUTMENT

PLACEMENT OF DENTURE RETAINING ABUTMENT

**PLACEMENT OF BALL ABUTMENT
AND RESTORATION**

RHEIN83 RETENTIVE CAPS

ABUTMENT REMOVAL

SCAN BODY

300

400

500

SURGICAL PROCEDURE



1 Make a full-thickness flap of the soft tissues to access the bone ridge.

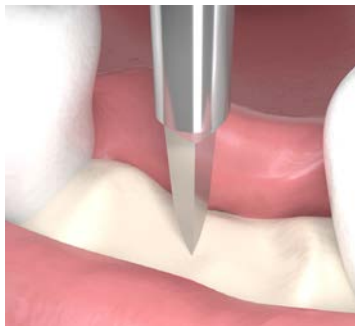

2 Use the lance drill to mark the cortical bone for the subsequent drills.



3 Use a pilot drill to establish orientation and initial depth for the parallel pin.



4 Use a parallel pin to evaluate parallelism with natural teeth or other adjacent implant sites.



5 Take an x-ray with the parallel pin inserted into the osteotomy to verify parallelism.

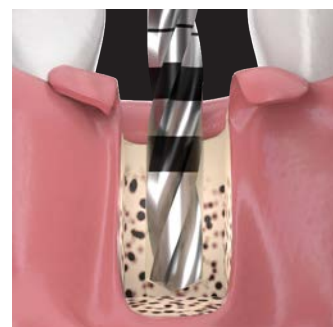

6 Widen the diameter of the implant site using sequential drills of increasing diameter. The drill depth should correspond to the length of the selected implant.

FINAL PLACEMENT OF IMPLANT



1 Remove the tray from the implant box, and peel back the tray cover, exposing the implant container.

Direct Placement Implants

Matching series color codes



2a Firmly press the implant driver (handpiece or ratchet) into the implant until it clicks. Pull the implant out of the container. **Skip to Step 6.**

—OR—

Implants with carriers

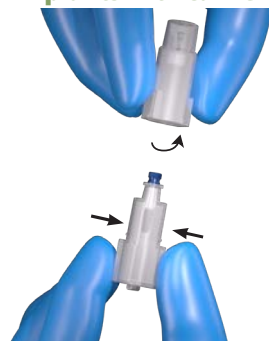

2b Hold the flat sides of the implant container firmly. Rotate the top portion of the container $\frac{1}{8}$ of a turn counter clockwise to remove the plastic cap, while holding the base closed.



FINAL PLACEMENT OF IMPLANT (Continued)

For implants with carriers only

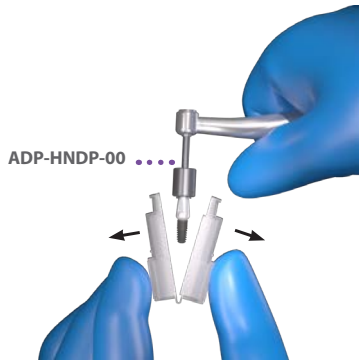

3 Snap a motorized hand piece, ratchet wrench, or thumb knob onto the exposed carrier and release the implant from the container tube.

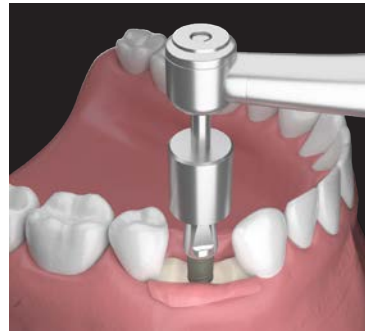

4 Rotate the implant into the osteotomy approximately half-way down or until finger tight.

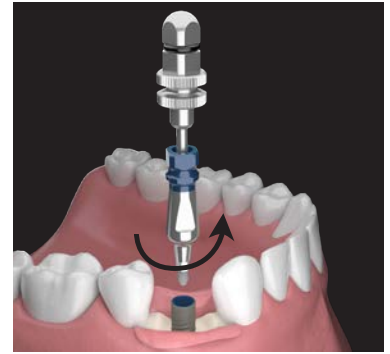

5 Remove the carrier by carefully placing the .050 hex driver into the carrier hole and turning counterclockwise.



The carrier should only be used to stabilize the implant in the osteotomy site and then be removed. Drive to final depth with an implant driver (see Step 6).



6 Use the appropriate implant driver from the surgical kit, and either the ratchet wrench or a motorized hand piece to rotate the implant into the osteotomy. The depth marks on the driver help you to gauge when you have reached the depth determined by the surgical plan. Do not exceed the maximum torque of 60 Ncm.

7 If installing a cover screw, remove the supplied cover screw from the implant container with an .050 Hex Driver in the Surgical Kit.

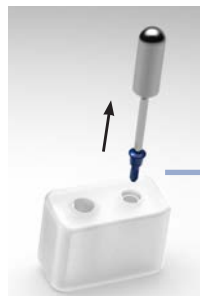

Direct Placement Implants

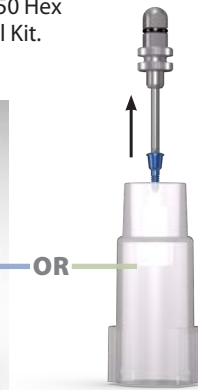

Implants with carriers

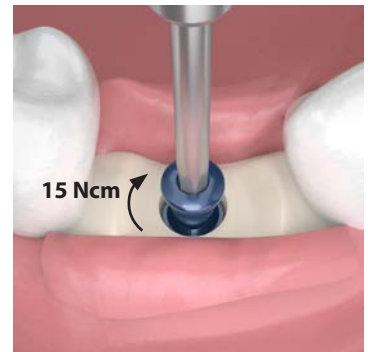

8 Drive the cover screw or healing cap into the implant to a maximum torque of 15 Ncm or finger tighten. Close and suture if needed.

IMPLANT ONE BONE PROFILER TOOLS

Sub-crestal placement of implants usually results in bone and soft tissue growing over the top of the implant during the integration period. The Implant One Bone Profiler tools safely remove this growth in order to thoroughly expose the implant for restoration. *Made of Stainless Steel.*

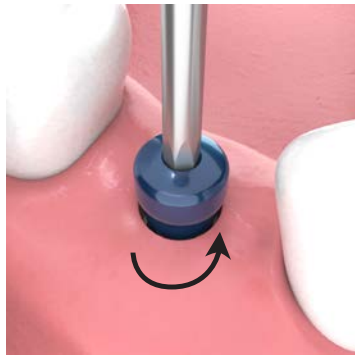

1 Remove the cover screw or healing cap.

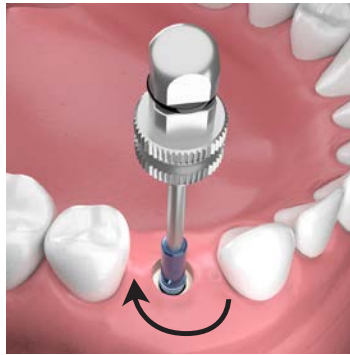

2 Install the guide pin which matches the implant's platform into the implant using an .050 Hex Driver.

The guide pins are color coded for each of the Implant One platforms.



GP300 GP400 GP500

The profilers are available in 3 sizes, to facilitate different emergence profiles.

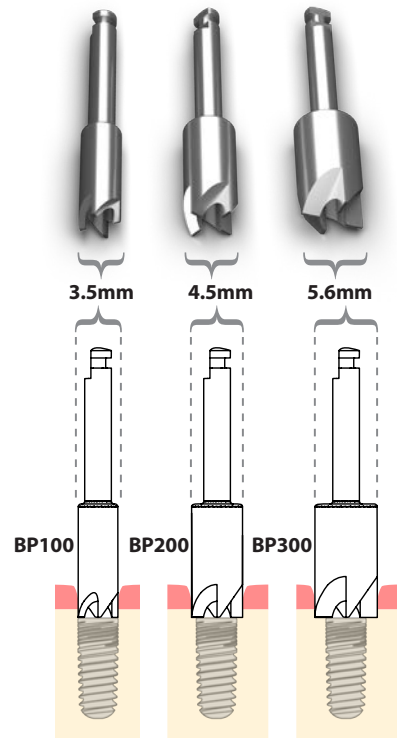

3 The profiler slides over the guide pin.



4 With a handpiece, rotate the profiler to cut away excess bone and tissue that has grown over the top of the implant. Remove the guide pin and continue with restoration.

Guide pins also available for Series 100 and 200



Products illustrated in this procedure: HDT-0050-00 hex driver, HCS-0330-00 healing cap, GP300 Guide Pin, BP100 Bone Profiler



CLOSED TRAY IMPRESSIONS



1 Remove tissue over the implant using a tissue punch or surgical blade.

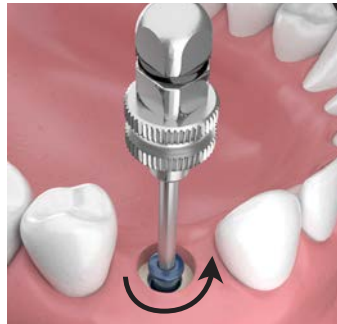

2 Remove cover screw with the .050 hex tool.



3 Use the Bone Profiler Kit to remove excess bone and tissue that has grown over the top of the implant. See page 34.



4 Align the appropriate series impression post into the implant. The impression post has a hex on the bottom which will fit into the internal hex in the implant. Finger tighten with .050 hex tool.

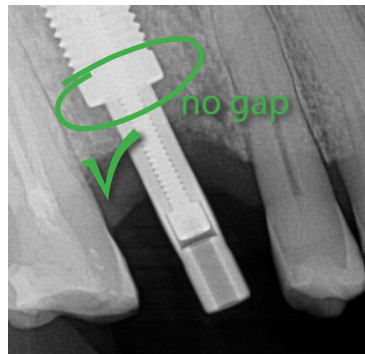

5 X-ray to verify proper seating of the impression post. There should be no gap between the implant and the impression post.

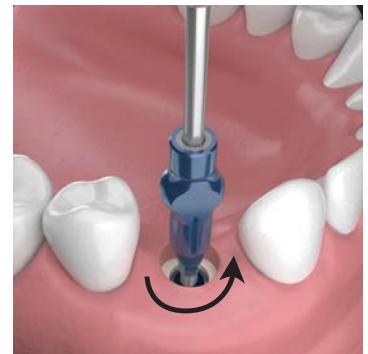

6 After impression is complete, use the .050 Hex Driver to turn the screw counter clockwise to remove the impression post from the implant. Send impression and impression post to the laboratory. If you decide to place the impression post back in the impression, attach an analog, or let the laboratory do that step.



7 Place a healing cap or temporary abutment with restoration on the implant while final restoration is being fabricated.

*Products illustrated in this procedure:
IPC-0300-00 closed tray impression post,
HCS-0330-00 healing cap, IR3-3508-00 implant,
HDT-0050-00 hex driver*

OPEN TRAY IMPRESSIONS

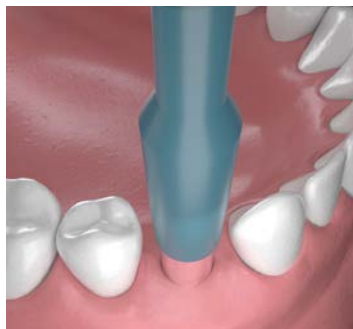

1 Remove tissue over the implant using a tissue punch or surgical blade.

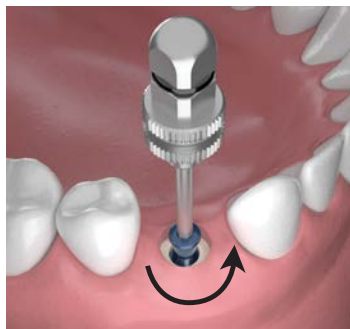

2 Remove cover screw with the .050 Hex Driver.

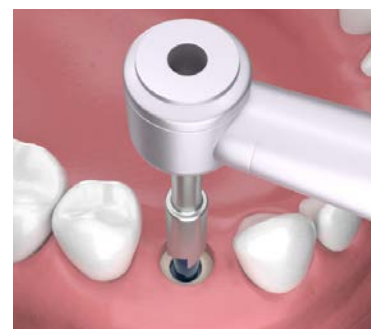

3 Use the Bone Profiler Kit to remove excess bone and tissue that has grown over the top of the implant. See page 34.



4 Align the appropriate series impression post into the implant. The impression post has a hex on the bottom which will fit into the internal hex in the implant. Finger tighten with .050 hex tool.

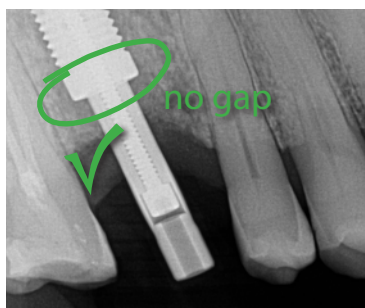

5 X-ray to verify proper seating of the impression post. There should be no gap between the implant and the impression post.

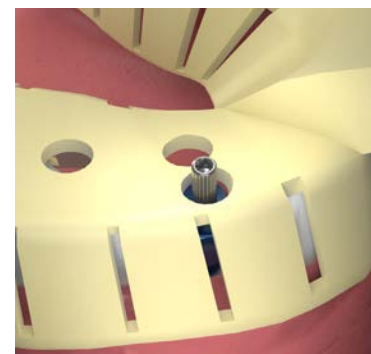

6 Customize the open tray so the impression post sticks out through the tray during the impression. Take the impression.

7 After impression is complete, use the .050 hex tool to turn the screw counter-clockwise to remove the center pin of the impression post. Remove the tray and impression post as one unit, and send to the laboratory.



impression post will be captured in impression

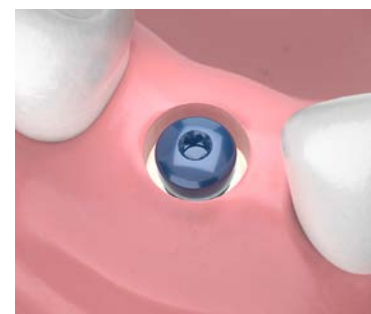
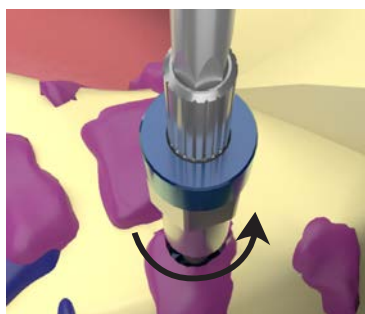

8 Place a healing cap or temporary abutment with restoration on the implant while final restoration is being fabricated.

36 Products illustrated in this procedure:
 IR3-3508-00 implant, HDT-0050-00 hex driver, IPO-0300-00 open tray impression post, HCS-0330-00 healing cap

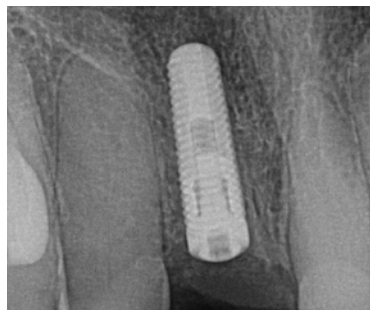
PLACEMENT OF HEALING CAP (*Healing Abutment, Tissue Former*)

1 X-ray to verify implant has appropriate integration.



2 Use biopsy punch or surgical blade to expose the cover screw of the implant.

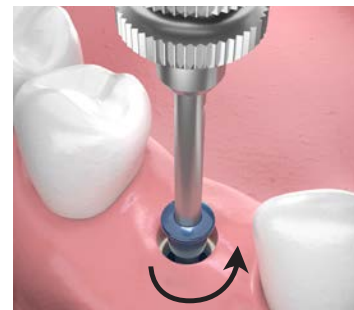

3 Remove cover screw with the .050 hex tool.



4 Use bone profiler if needed. See page 47.

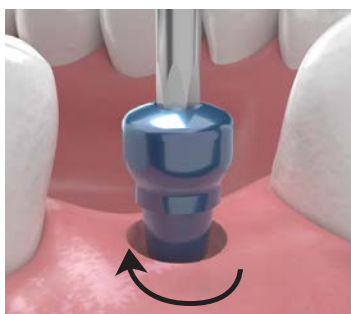

5 Place the appropriate healing cap (see below) to aid in the tissue development and emergence profile for the final restoration. Tighten to 10Ncm or finger tight.

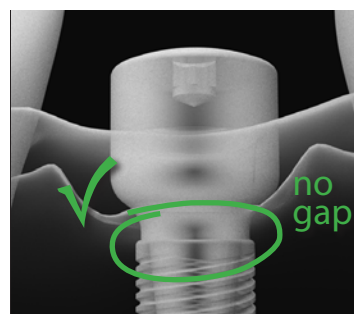

6 X-ray to verify the healing cap is fully seated.

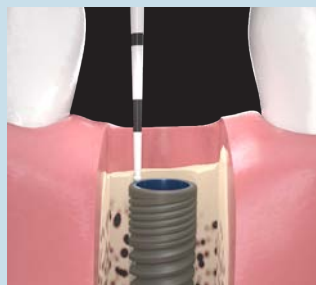
Determining Appropriate Cuff Height and Width

Cuff height: Measure from the top of the implant to the top of the tissue and add one mm.

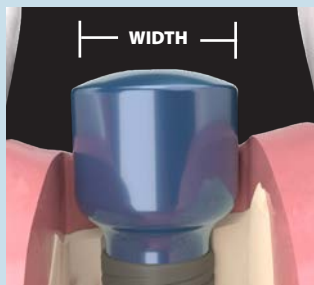

Width: Determined by the emergence profile the doctor is trying to develop in the soft tissue.

Molars will have a significantly wider emergence profile than an anterior tooth.

If implant is sub-crestal, use a narrow healing cap as it will not interfere with the adjacent bone when seating.

PLACEMENT OF **ABUTMENT AND CEMENT RETAINED RESTORATION**

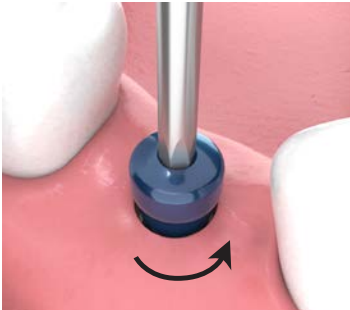

1 Use an .050 Hex Driver to turn the healing cap counterclockwise and remove it.

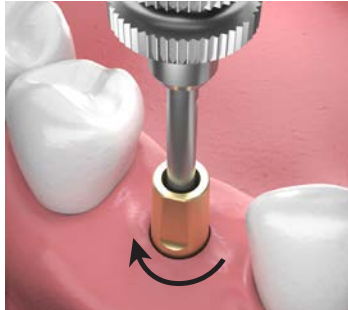

2 Insert the final abutment into the implant using the proper orientation. Tighten to finger tight.



3 Try on the final restoration



4 Verify proper fit of restoration, proper contacts, proper occlusion. Take an x-ray to verify restoration is fully seated.



5 Remove the restoration and tighten the abutment with a torque wrench.

*Torque specifications:
300 Series: 20 Ncm
400 & 500 Series: 30Ncm*

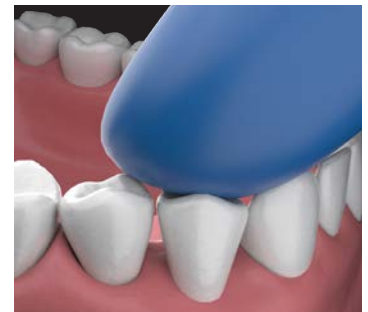

6 Cement the crown over the abutment. Remove excess cement.



PLACEMENT OF **MULTI-UNIT ABUTMENT** (*MUA, transmucosal*)

Multi-unit Abutments are used to secure multi-unit screw-retained prosthetics in one of the following case types:

1. Attaching Zirconia hybrid prosthetics.
2. Retrofitting a pre-made denture following immediate placement and immediate load of a temporary/healing prosthesis. These healing appliances and attachments are generally replaced with the final prosthesis following implant integration.
3. Attaching a milled or cast titanium bar which supports a denture type restoration attached to the metal substructure.

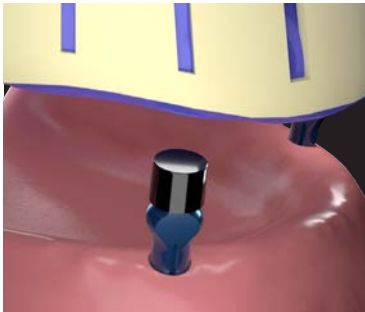

1 Take an implant level impression using standard impression posts. Send impression to the laboratory for them to pick the correct Multi-unit Abutments and make a customized open tray.

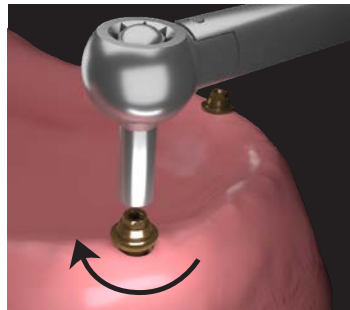

2 APPT 2: When case is returned from the laboratory, remove healing caps, insert abutments, and drive them into the implants using the DEH-0910-32 Abutment Driver and a torque wrench.

Torque specifications: 300 Series: 20 Ncm, 400 & 500 Series: 30Ncm

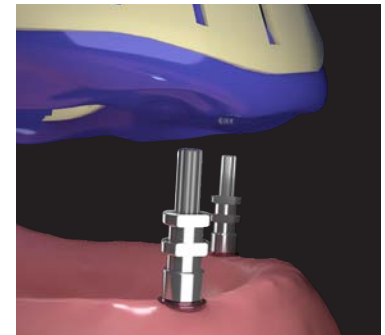

3 Using the custom tray, take a second impression with the MUA-0345-IP Impression Copings over the abutments. Send impression to the laboratory for master cast, base plate and wax rims for jaw relations.

4 APPT 3: When case is returned from the laboratory use the base plate and wax rims to register jaw relations. Send to laboratory.



5 APPT 4: When case is returned from the laboratory, try in the polymethylmethacrylate (PMMA) setup. Make adjustments as necessary during the temporary period (6 weeks recommended).

After the adjustments have been made and appliance is satisfactory, remove appliance and return to laboratory for scan of the modified appliance and creation of new final appliance.



6 APPT 5: When final appliance is returned, insert prosthesis and tighten sleeve screws to 20 Ncm.

PLACEMENT OF POSITIONER **DENTURE RETAINING ABUTMENT**

Denture Retaining Abutments are used to secure removable denture prosthetics.

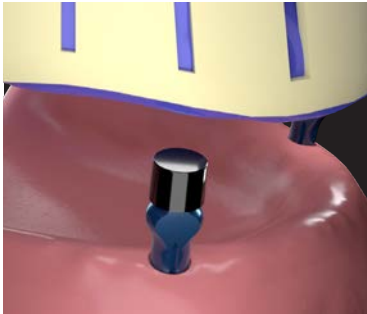

1 Take an implant level impression using standard impression posts. Send impression to the laboratory for them to pick the correct abutments and make a customized tray.

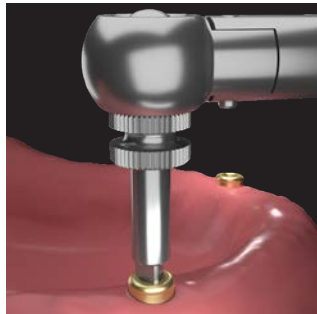

2 APPT 2: When case is returned from the laboratory, remove healing caps, insert abutments, and drive them into the implants using the DLR-0345-00 Abutment Driver and a torque wrench.

*Torque specifications:
300 Series: 20 Ncm
400 & 500 Series: 30Ncm*

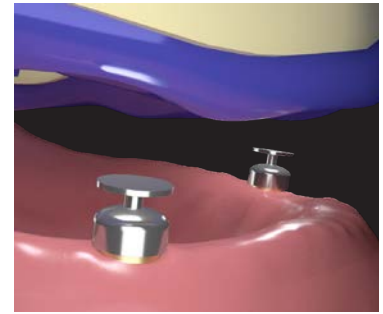

3 Using the custom tray, take a second impression with the appropriate impression copings over the abutment. Send impression to the laboratory for master cast, base plate and wax rims for jaw relations.

4 APPT 3: When case is returned from the laboratory use the base plate and wax rims to register jaw relations. Send to laboratory.



5 APPT 4: When case is returned from the laboratory, try in denture setup. Make adjustments as necessary before processing final restoration.

6 APPT 5: When final denture is returned insert appliance, adjust occlusion, retention caps and denture base as necessary.



PLACEMENT OF BALL ABUTMENT AND RESTORATION

Ball Abutments are used to secure removable denture prosthetics.

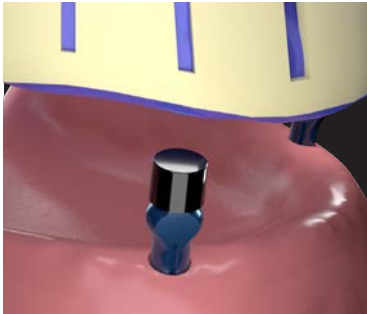

1 Take an implant level impression using standard impression posts. Send impression to the laboratory for them to pick the correct ball abutments and make a customized tray.

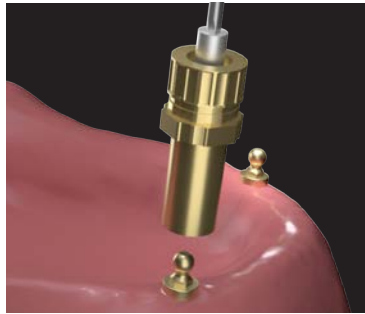

2 APPT 2: When case is returned from the laboratory, remove healing caps, insert abutments, and drive them into the implants using the DEH-0000-00 Ball Abutment Driver and a torque wrench.

*Torque specifications:
300 Series: 20 Ncm
400 & 500 Series: 30Ncm*

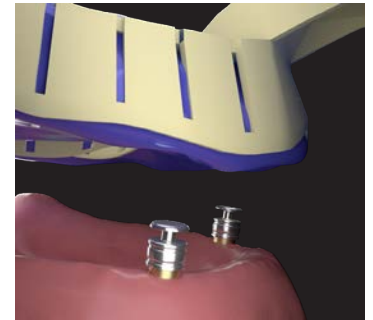

3 Take a second impression using a custom tray, with abutments in place and Rhein Impression Transfers over the abutments. Send impression to the laboratory for master cast, base plate and wax rims for jaw relations.

4 APPT 3: When case is returned from the laboratory use the base plate and wax rims to register jaw relations. Send to laboratory.



5 APPT 4: When case is returned from the laboratory, try in denture setup. Make adjustments as necessary before processing final restoration.

6 APPT 5: When final denture is returned insert appliance, adjust occlusion, retention caps and denture base as necessary.

Choosing Platform Height for Ball Abutments

Measure from the top of the implant to the top of the tissue and add one to two mm.



PLACEMENT OF RHEIN83 RETENTIVE CAPS

In a prosthesis with metal housings, remove caps using a rotary tool at a low RPM, or the Rhein83 cap removal tool. For all others, use a pointed instrument, such as a spatula, or the Rhein83 cap extractor tool.

Insert the new caps with the Rhein83 cap insertion tool. Green caps inserted in metal housings should have a drop of cyanoacrylic adhesive applied to the inside of the housing before insertion.

RHEIN83 RETENTIVE CAP COLORS AND RETENTION:		
Cap Color/Name		Retention
Clear		Standard
Pink		Soft
Yellow (Standard and Undersized Internal Diameter)		Extra Soft
Green		Very Elastic
Extra Resilient Gold		Slightly Elastic
Extra Resilient Silver		Elastic
Titan		Standard
Gray		Rigid



ABUTMENT REMOVAL PROCEDURE

Permanent abutments are easily removed in the Implant One system with an abutment removal tool unique for a tapered implant connection.



Using a .050 tapered hex driver, unscrew the fixation screw.

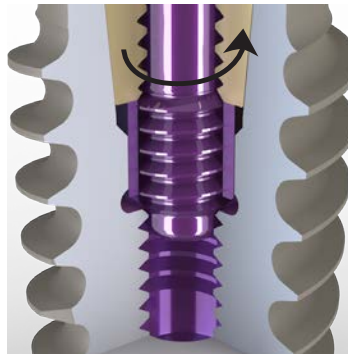

Continue turning the fixation screw counter-clockwise until it disengages the threads of the implant. You will feel it clicking when this happens.

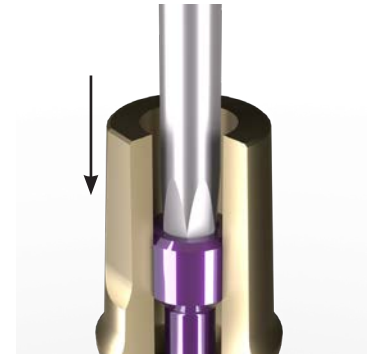

Apply downward force on the hex driver to catch and fix the driver to the screw.

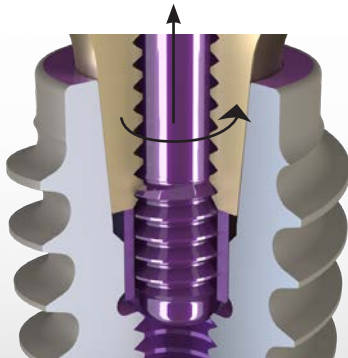

Gently lift up the driver while rotating it counter-clockwise to engage the screw in the internal threads of the abutment.



You may now unscrew the fixation screw out of the abutment.



Insert an abutment removal tool and turn it clockwise until it reaches the bottom of the abutment.

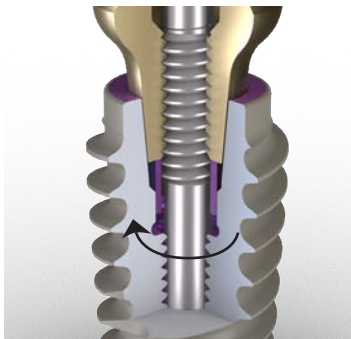

Continue to turn the abutment removal tool until the abutment releases from the tapered connection of the implant.

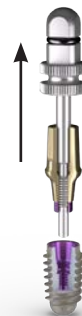

The abutment is now easily pulled out of the implant.

*Products illustrated in this procedure:
.050 Hex Driver - HDT-0050,
Abutment Extractor - EXT-0172*

IMPLANT ONE **SCAN BODY PROCEDURE**

The Implant One Scan Body is designed with specialized geometry that helps CAD software pinpoint the exact location of an Implant One implant, its timing, and its relationship to the arch form. Follow the steps below to ensure the most accurate scans for your patients' restorations.

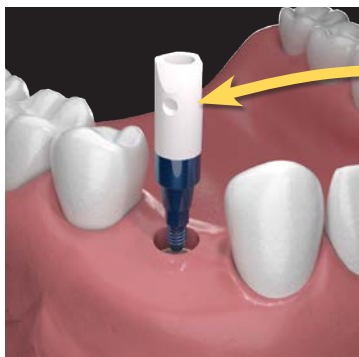

IMPORTANT:
The dimple must face the buccal or the facial in order to get an acceptable scan.

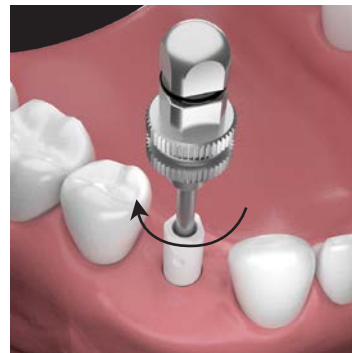

1 Place the scan body into the implant or analog. The scan body's series and the implant's series must match, e.g., 300 Series to 300 Series.

2 Finger tighten the abutment screw with an Implant One tapered .050" hex driver (HDT).

SEATED

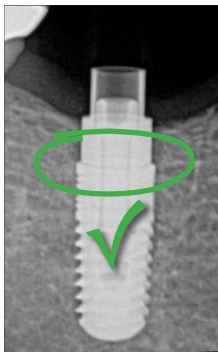

NOT-SEATED

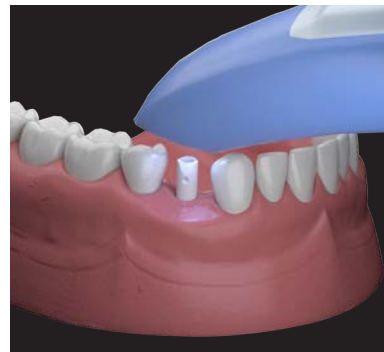
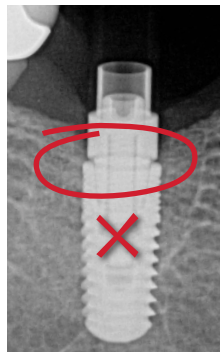

3 Take an X-ray to confirm proper seating of the scan body (intraoral only). There should be no gap between the implant and the scan body.

4 Take the optical scan with the scan body properly installed.

INFORMATION **SHEETS:**

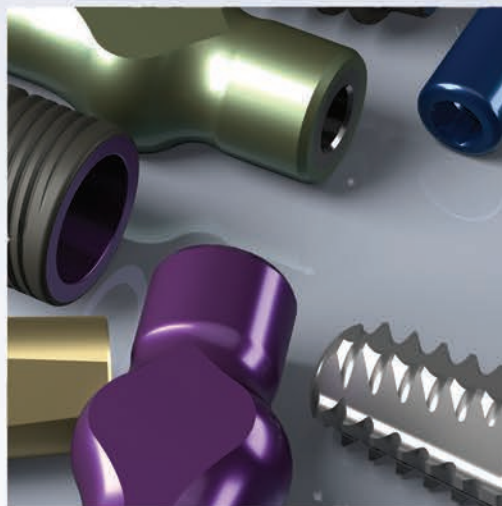

**INTENDED USE OF
SURGICAL KIT COMPONENTS**

DIRECT PLACEMENT IMPLANTS

CARRIER FEATURES

ABUTMENT SCREW

300

400

500

INTENDED USE OF SURGICAL KIT COMPONENTS

OPTIONS FOR REMOVING IMPLANT WITH CARRIER FROM CONTAINER AND PLACING IN OSTEOTOMY

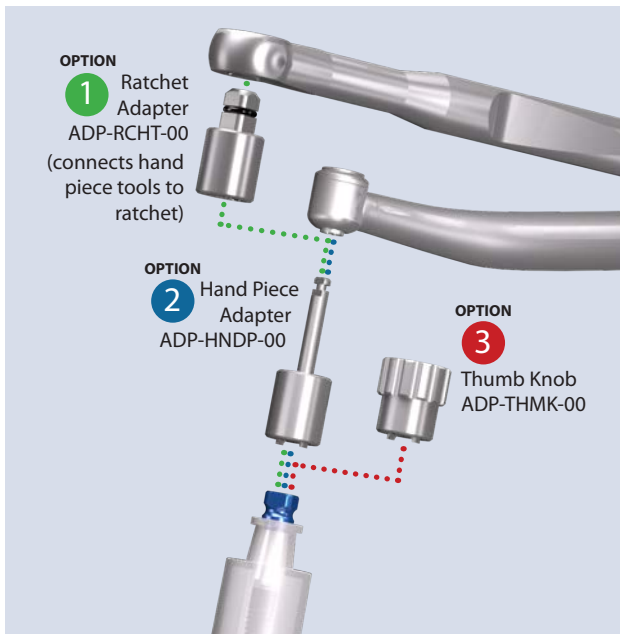

OPTIONS FOR DRIVING IMPLANT TO FULL DEPTH

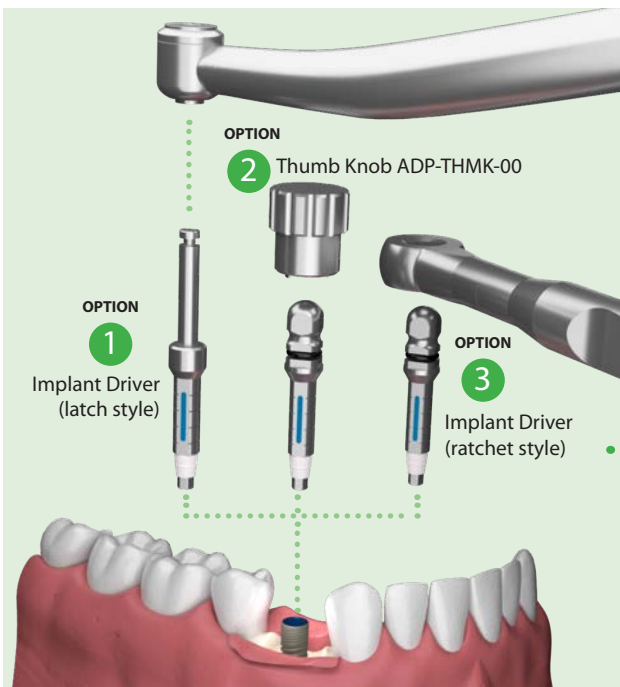

OPTIONS FOR REMOVING CARRIER FROM IMPLANT

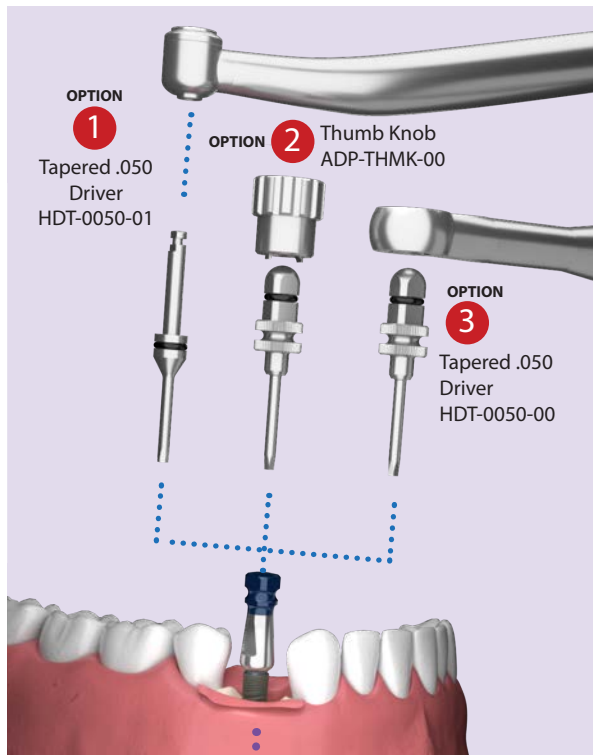

! Do not drive implant to full depth with the carrier – it may damage the hex connection inside the implant.

Use one of these options with Direct Placement implants (see next page)



IMPLANT ONE DIRECT PLACEMENT IMPLANTS

Many of our implants are now equipped with the Direct Placement feature which eliminates the need for a carrier.



Implant One implant drivers come with specially-designed PEEK fittings that securely snap into implants

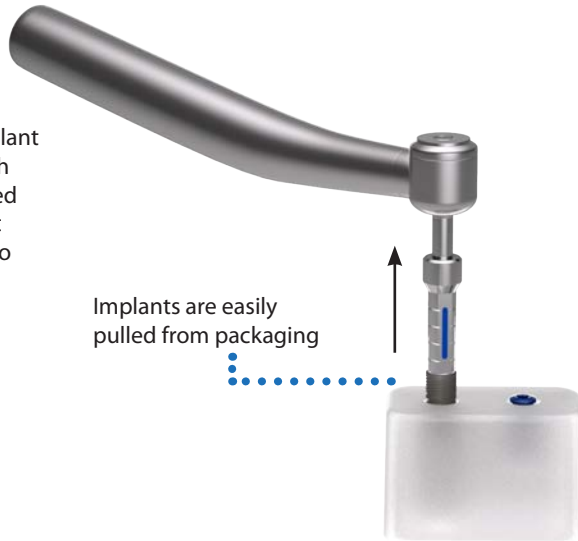

Implants are easily pulled from packaging

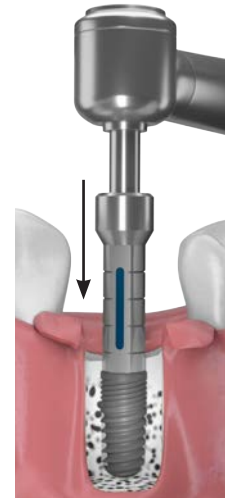

Implants are directly placed into their osteotomy sites and driven to full depth. No intermediate steps required.

IMPLANT ONE CARRIER FEATURES

Carriers are used to transfer an implant to the osteotomy when the Direct Placement feature is not available.

- Auto-Removal feature simplifies removal of the carrier from the implant after it is stabilized in the osteotomy.
- The carrier can be cut off and used as a temporary abutment.

SPECIFICATIONS
Material: 6AL4V E.L.I. Titanium
Profile Diameter: 4.5 mm – 5.5 mm
.050" hex interface

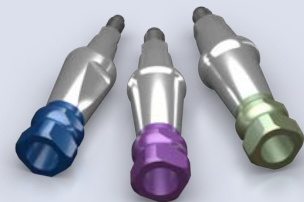

Screw can be loosened using a Hand Piece Driver, or a Ratchet/Finger Driver



Auto-Removal feature forces carrier out of implant as .050" hex fixation screw is turned counter-clockwise



Handpiece adapter or thumb knob snaps onto carrier allowing for easy, sterile transfer from packaging to osteotomy

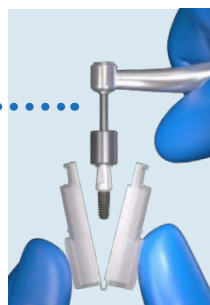

Color-coded anodization for easy platform identification



IMPLANT ONE **ABUTMENT SCREW**

Usage:

The tip of the abutment screw should protrude approximately 2.6mm (5 to 6 exposed threads).

When turning the screw into the implant, the screw should turn 5 to 6 turns for proper thread engagement. Do not exceed specified torque.

SPECIFICATIONS
Material: 6AL4V E.L.I. Titanium
Diameter: 1.1 mm – 1.4 mm
Height: 9.6 mm
.050" hex interface

300 Series
HHS-0300-00



Max Torque
20 Ncm

1.1 mm

400 Series
HHS-0400-00



Max Torque
30 Ncm

1.4 mm

500 Series
HHS-0500-00

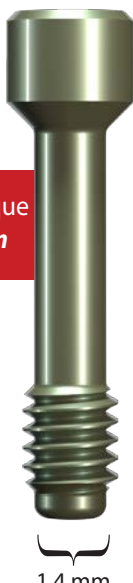

1.4 mm

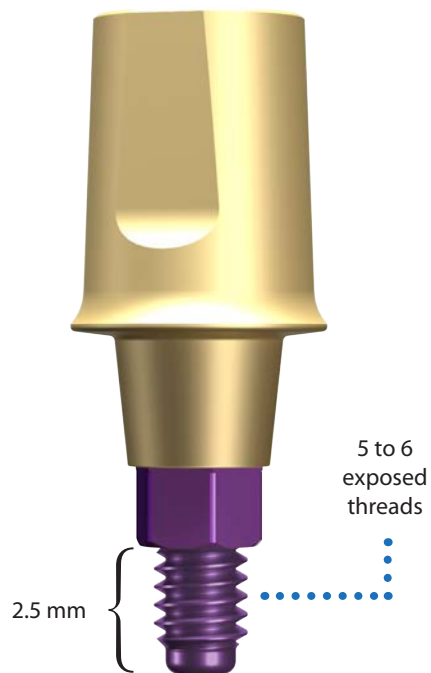



IMPLANT ONE GLOSSARY

Abutment A part used to connect a crown to an implant.

Analog A part used by the laboratory to replicate implants and their position in a dental model. The analog is screwed onto the impression coping then set into a plaster model during casting.

Anodization Process of coating a metal with a colored, protective film by chemical or electrolytic means.

Carrier This part comes attached to the implant in the package. This is a removable piece that helps the dentist transfer the implant from the package to the osteotomy site without having to touch the implant.

Cover Screw *alternate terms: healing screw, cover cap* Placed over the implant during the healing period to keep the inside of the implant free of bacteria, tissue and bone.

Cuff Height On an abutment, the distance from the top of the implant to the bottom of the restoration (not necessarily the bone ridge since the implant can be placed sub-crestal).

Dental Implant An artificial tooth root that provides a stable and permanent base for a replacement tooth.

Fixation Screw Screw used to fully engage an abutment to its implant. In the Implant One system, it is the taper of the implant-abutment connection that makes a permanent, sealed bond between them. See Morse Taper.

Gingival Height Measurement from the top of the bone to the top of the gingiva.

Healing Cap A tall cap that covers the top of the implant after it is integrated, keeping the implant free of bacteria, tissue and bone, and helps properly shape the gingiva for the placement of the abutment and crown once it returns from the lab.

Implant Driver Tool that interfaces directly with an implant and is used to drive it to final depth. Carriers must be removed when the torque exceeds 6 Ncm.

Impression A negative imprint of hard and soft tissues in the mouth from which a positive reproduction can be formed. Used by laboratories to create accurate custom abutments and crowns.

Impression Coping An accessory used to pinpoint the exact position of the implant on the dental impression.

Irrigation Process of cleaning a wound by flushing or washing out with water or a medicated solution.

Morse Taper A self-holding, steeply tapered connection between two mechanical components used widely in the orthopedic, aeronautical, and mechanical machining industries. The unique attributes of this connection create a very strong, and hermetically sealed connection, which, in the Implant One system, prevents bacteria from growing inside its implants. The Morse taper was invented by Stephen A. Morse in 1864.

Overdenture A complete denture supported both by mucosa and by a few remaining natural teeth and/or dental implants to permit the denture to fit over them.

Profile Diameter The outer diameter of an abutment where it meets the gingival tissue.

Profiler Tool used to cut away excess bone and tissue that has grown over the top of the implant during healing period prior to restoration.

RPM Revolutions per minute.

Sub-crestal Refers to placing an implant below the crest of the bone ridge.

Surgical Stent An appliance made prior to surgery that helps guide the surgical drills during the implant surgery.

Torque The force that produces rotation, measured in Newton Centimeters (Ncm). Too much torque will cause damage to bone cells.



IMPLANT
— ONE —



IMPLANT
LOGISTICS

 **IMPLANT**
LOGISTICS

implantlogistics.com

IMPLANT ONE SERIES



IMPLANT
— ONE —
PRECISION DENTAL IMPLANTS



IMPLANT
LOGISTICS
INNOVATIVE DENTAL TECHNOLOGY

711 Spartan Dr. Sparta | WI 54656

(608) 498-4855 | 844-383-8001